

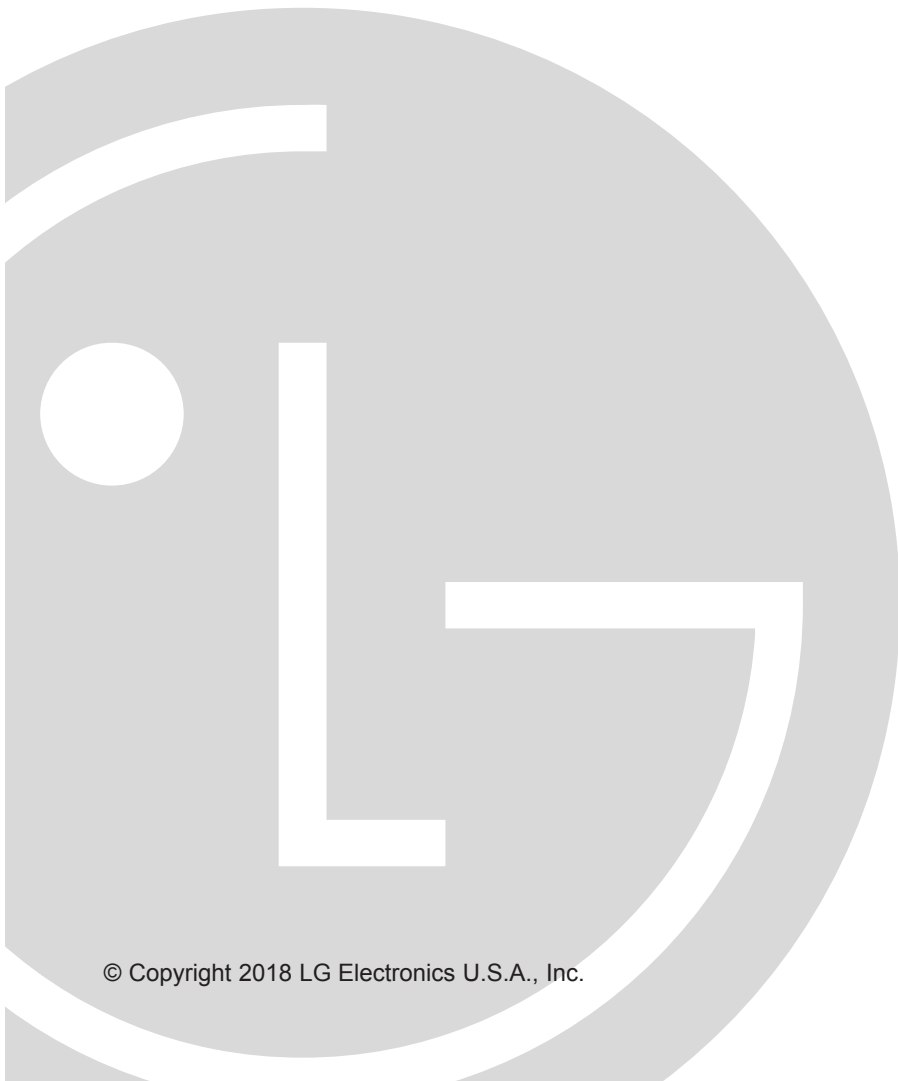



PCS400R Pro:Centric[®] Server

Installation & Setup Guide Warranty



For Customer Support/Service, please call: **1-888-865-3026**

The latest product information and documentation is available online at: www.lg.com/us/business



WARNING
RISK OF ELECTRIC SHOCK
DO NOT OPEN



WARNING:
TO REDUCE THE RISK OF ELECTRIC SHOCK DO NOT REMOVE COVER (OR BACK). NO USER-SERVICEABLE PARTS INSIDE. REFER TO QUALIFIED SERVICE PERSONNEL.



The lightning flash with arrowhead symbol, within an equilateral triangle, is intended to alert the user to the presence of uninsulated “dangerous voltage” within the product’s enclosure that may be of sufficient magnitude to constitute a risk of electric shock to persons.



The exclamation point within an equilateral triangle is intended to alert the user to the presence of important operating and maintenance (servicing) instructions in the literature accompanying the appliance.

WARNING:

TO PREVENT FIRE OR SHOCK HAZARDS, DO NOT EXPOSE THIS PRODUCT TO RAIN OR MOISTURE.

Apparatus shall not be exposed to dripping or splashing and no objects filled with liquids, such as vases, shall be placed on the apparatus.

L'appareil ne doit pas être exposé à des égouttements d'eau ou des éclaboussures et de plus qu'aucun objet rempli de liquide tel que des vases ne doit être placé sur l'appareil.

WARNING:

This product contains chemicals known to the State of California to cause cancer and birth defects or other reproductive harm. ***Wash hands after handling.***

FCC NOTICE (For USA and Canada):

This equipment has been tested and found to comply with the limits for a Class A digital device, pursuant to Part 15 of the FCC Rules. These limits are designed to provide reasonable protection against harmful interference when the equipment is operated in a commercial environment. This equipment generates, uses and can radiate radio frequency energy and, if not installed and used in accordance with the instructions manual, may cause harmful interference to radio communications. Operation of this equipment in a residential area is likely to cause harmful interference in which case the user will be required to correct the interference at his own expense.

This device complies with part 15 of the FCC Rules. Operation is subject to the following two conditions: (1) this device may not cause harmful interference and (2) this device must accept any interference received, including interference that may cause undesired operation of the device. Any changes or modifications in construction of this device which are not expressly approved by the party responsible for compliance could void the user's authority to operate the equipment.

CAUTION:

Do not attempt to modify this product in any way without written authorization from LG Electronics U.S.A., Inc. Unauthorized modification could void the user's authority to operate this product.

COMPLIANCE:

The responsible party for this product's compliance is: LG Electronics U.S.A., Inc.
2000 Millbrook Drive, Lincolnshire, IL 60069, USA • Phone: 1-847-941-8000

Marketed and Distributed in the United States by LG Electronics U.S.A., Inc.
2000 Millbrook Drive, Lincolnshire, IL 60069

IMPORTANT SAFETY INSTRUCTIONS

1. Read these instructions.
2. Keep these instructions.
3. Heed all warnings.
4. Follow all instructions.
5. Do not use this apparatus near water.
6. Clean only with dry cloth.
7. Do not block any ventilation openings. Install in accordance with the manufacturer's instructions.
8. Do not install near any heat sources, such as radiators, heat registers, stoves, or other apparatus (including amplifiers) that produce heat.
9. Do not defeat the safety purpose of the polarized or grounding-type plug. A polarized plug has two blades with one wider than the other. A grounding-type plug has two blades and a third grounding prong. The wide blade or the third prong are provided for your safety. If the provided plug does not fit into your outlet, consult an electrician for replacement of the obsolete outlet.
10. Protect the power cord from being walked on or pinched, particularly at plugs, convenience receptacles, and the point where it exits from the apparatus.
11. Only use attachments/accessories specified by the manufacturer.
12. Use only with the cart, stand, tripod, bracket, or table specified by the manufacturer or sold with the apparatus. When a cart is used, use caution when moving the cart/apparatus combination in order to avoid injury from tip-over.
13. Refer all servicing to qualified service personnel. Servicing is required when the apparatus has been damaged in any way, such as power-supply cord or plug is damaged, liquid has been spilled or objects have fallen into the apparatus, the apparatus has been exposed to rain or moisture, does not operate normally, or has been dropped.
14. **Power Sources**

This product should be operated only from the type of power source indicated on the marking label. If you are not sure of the type of power supply to your INSTALLATION, consult your product dealer or local power company.
15. **Overloading**

Do not overload wall power outlets and extension cords as this can result in a risk of fire or electric shock.
16. **Disconnect Device**

The AC mains plug is used as the disconnect device. The disconnect device must remain readily operable.
17. **Object and Liquid Entry**

Never push objects of any kind into this product through openings as they may touch dangerous voltage points or short-out parts that could result in a fire or electric shock. Never spill liquid of any kind on the product. Do not use liquid cleaners or aerosol cleaners.
18. **Outdoor Use**

 **Warning: To prevent fire or shock hazards, do not expose this product to rain or moisture.**
19. **Wet Location**

Do not use this product near water or moisture or in an area, such as a basement, that might become flooded. The apparatus shall not be exposed to dripping or splashing and no objects filled with liquids, such as vases, shall be placed on the apparatus.
20. **Test Equipment**

In some cases, LG has supplied or recommended the use of test equipment and devices for the setup and testing of the equipment. The operation and maintenance of test equipment is described in their associated instruction manuals. Please refer to these manuals for explicit instructions regarding the safe use and handling of the equipment.

(Continued on next page)

IMPORTANT SAFETY INSTRUCTIONS

(Continued from previous page)

21. Damage Requiring Service

Unplug this product from the wall power outlet and refer servicing to qualified service personnel under the following conditions:

- a. If the power-supply cord or plug is damaged.
- b. If liquid has been spilled, or objects have fallen into the product.
- c. If the product has been exposed to rain or water.
- d. If the product does not operate normally by following the operating instructions. Adjust only those controls that are covered by the operating instructions, as an improper adjustment of other controls may result in damage and will often require extensive work by a qualified technician to restore the product to its normal operation.
- e. If the product has been dropped or the cabinet has been damaged.
- f. If the product exhibits a distinct change in performance.



Caution: Refer all servicing to qualified service personnel.

22. Servicing



Caution: These servicing instructions are for use by qualified service personnel only. To reduce the risk of electrical shock, do not perform any servicing other than that described in the operating instructions unless you are qualified to do so.

23. Replacement Parts

When replacement parts are required, be sure the service technician uses replacement parts specified by the manufacturer or that have the same characteristics as the original parts. Unauthorized substitutions may result in fire, electric shock, or other hazards.

24. Safety Check

Upon completion of any service or repairs to this product, ask the service technician to perform safety checks to determine that the product is in proper operating condition.

25. Handling Notice



Caution: Only qualified service personnel should handle and install this unit. A series of screws with lock washers are used to secure the top and bottom covers of the unit. Use caution when handling the unit as the lock washers may have rough edges. Do NOT run your fingers over the top and bottom covers of the unit.

IMPORTANT SAFETY INSTRUCTIONS

PCS400R Rack Installation

(also see pages 12 to 13)

- Wear a properly grounded, antistatic wrist strap to avoid causing electrostatic (ESD) damage to the PCS400R.
- Carefully slide the PCS400R into a standard 19-inch equipment rack.
- When mounting in the rack, make sure to use the appropriate hardware. **ALL FOUR MOUNTING SCREWS MUST BE USED.**
- This equipment is not designed to support other devices. Do NOT stack other equipment on the top of the PCS400R.
- Rear cabling must be dressed and supported so that the weight of the cabling is not a strain on the PCS400R connectors.
- **MOUNTING OF THE EQUIPMENT IN THE RACK SHOULD BE SUCH THAT A HAZARDOUS CONDITION IS NOT ACHIEVED DUE TO UNEVEN MECHANICAL LOADING.**

Rack-mount Considerations

A. Elevated Operating Ambient

If installed in a closed or multi-unit rack assembly, the operating ambient temperature of the rack environment may be greater than room ambient. Therefore, consideration should be given to installing the equipment in an environment compatible with the maximum ambient temperature (T_{ma}) specified by the manufacturer (see Specifications information in this document).

B. Reduced Air Flow

Installation of the equipment in a rack should be such that the amount of air flow required for safe operation of the equipment is not compromised. To ventilate the system normally and avoid overheating, leave at least 1 inch (2.5 cm) on each side (including top and bottom) of the PCS400R. Do NOT stack other equipment on the top of the PCS400R. Also, ensure that the unit's AC power adapter is never stacked or bundled with other AC power adapters. Each adapter should have adequate ventilation and should be isolated from other heat sources.

C. Circuit Overloading

Consideration should be given to the connection of the equipment to the supply circuit and the effect that overloading of the circuits might have on overcurrent protection and supply wiring.

D. Reliable Earthing

Maintain reliable earthing of rack-mounted equipment. Particular attention should be given to supply connections other than direct connections to the branch circuit (e.g., use of power strips).

E. Mains Outlet Earthing

The apparatus with Class I construction must be connected to a mains socket outlet with a protective earthing connection.

Table of Contents

Safety Warnings	2	Set the Time Zone	29
Important Safety Instructions.	3–5	Set the Date and Time	31
Table of Contents	6	Change the Login Password	31
PCS400R Product Description	7	Change the Portal Application	33
Setup Information	8–10	Monitor the System	34
Rear and Front Panel Overviews	11	Send Ping Commands to Network Hosts	35
Rack Installation	12–13	Update the PCS400R Operating System	35
Typical Rack Installation	12	Update the VPN Setup.	37
Rack-mount Considerations.	13	Shut Down the System	38
System Setup	14–21	Reset the System.	38
Typical Setup Diagram for PCS400R with ASI Output	14	Reinstall the Factory Configuration	38
Typical Setup Diagram for PCS400R with RF Output.	15	Exit the Current Session	39
Typical Setup Diagram for PCS400R with IP Output	16	Troubleshooting.	40–41
VPN Network Connections Overview	16	PCS400R Setup.	40
Setting Up the Pro:Centric Network.	17	PCS400R Communication.	41
PCS400R Configuration Options.	22–39	Specifications	42
Network and Communication Setup	22	Document Revision History / Notes	43
Log In to the PCS400R and Access the Main Menu	23	Open Source Software Notice.	44–96
View System Information	24	Warranty	Back Cover
Modify Network Settings	25		
Modify the Server Host Name	28		

Notes

- Design and specifications subject to change without prior notice.
- This document provides examples of typical command line interface and text-based user interface (TUI) displays. Your displays may vary from those shown in this document.

PCS400R Product Description

The LG PCS400R Pro:Centric[®] server is a stand-alone, remotely-controlled processor and controller for the Pro:Centric system. The server enables you to create and remotely manage portal and application content for LG TVs, using either the Pro:Centric Java or Pro:Centric Direct HTML application.

Features

- Supports the Pro:Centric Java or Pro:Centric Direct HTML application
- Three output options: ASI, RF, or IP
 - ASI output: The PCS400R generates one channel for GEM data only or multiplexed GEM/site data.
 - RF output: QAM-B (6 MHz), DVB-C (6 MHz, 7 MHz, or 8 MHz), and ISDB-T (6 MHz) modulations are supported. The PCS400R generates one 256-QAM or 64-QAM RF channel for GEM/site data.
 - IP output: The PCS400R generates two multicast streams for GEM/site data.
- Customer may work with content provider to create Pro:Idiom[®] encrypted content for RF or IP video playout channels
 - QAM-B and DVB-C RF output: In addition to the GEM/site data channel, the PCS400R generates up to seven contiguous RF channels for video playout. Each of these channels supports either two or three program streams multiplexed on each channel. This capability provides output of up to 21 programs of video content.
 - ISDB-T RF output: In addition to the GEM/site data channel, the PCS400R generates up to one (Java application) or two (HTML application) contiguous RF channels for video playout. Each of these channels supports either two or three program streams multiplexed on each channel. This capability provides output of up to three (Java application) or six (HTML application) programs of video content.
 - IP output: In addition to two multicast streams for GEM/site data, the PCS400R generates 21 multicast data streams for video playout. Each data stream supports one program. This capability provides output of up to 21 programs of video content.
- Provides remote management capability over Ethernet
- Small, lightweight chassis
- 19-inch rack-mountable
- 1U height profile to minimize rack space usage

An Internet browser-based Admin Client graphical user interface (GUI), provided for system integrator (SI) partners and lodging/institution administrators, facilitates support and maintenance of the Pro:Centric system. The Admin Client enables users to remotely manage system backups, output configuration, software updates, portal/information section content, TV configuration settings, etc.

Setup Information

Check the following items before you begin the PCS400R installation and setup procedures.

Note: Once the PCS400R hardware and software is installed and the initial setup completed, output parameters are configured in the appropriate Pro:Centric Admin Client. Along with this document, it is recommended that you have readily available a copy of either the **Pro:Centric Server Admin Client User Guide** (for the Java application) or the **Pro:Centric Direct Admin Client User Guide** (for the HTML application), as applicable.

PCS400R

___ Unpack the PCS400R Pro:Centric server unit and all accessories.

PCS400R Accessories: • AC Power Cord and Adapter

___ Select the location for mounting the PCS400R. Ensure adequate ventilation is available.

___ Obtain the necessary attachment hardware to mount the PCS400R chassis in its targeted location.

___ Plan and install the necessary cabling and network (Ethernet) and AC power access for the PCS400R. You also will need the following to connect a PC directly to the PCS400R for system setup purposes: FTDI TTL-USB cable (P/N TTL-232R-5V-AJ).

Video Channel Assignments for RF Output (QAM-B)

Each input program is limited to one-half or one-third of the output channel bitrates (Mbps), which in turn are dependent on the modulation format. 256-QAM modulation supports up to 38.8 Mbps per channel, and 64-QAM modulation supports up to 26.97 Mbps per channel.

___ Create a channel assignment plan for the installation site, or modify an existing plan to incorporate the RF output of the PCS400R. Ensure that up to eight contiguous CATV broadcast channels are allocated for the PCS400R RF output. The PCS400R uses a 256-QAM or 64-QAM modulation format, thereby occupying approximately 48 MHz of frequency spectrum.

The RF start channel is user-assigned during system setup (in the Admin Client), and the remaining channels (up to seven) are then automatically assigned per EIA-542 STD CATV frequency allocation standards. For example, if the RF start channel assignment is channel 2, the seven remaining channels will be 3, 4, 5, 6, 95, 96, and 97. Refer to EIA-542 STD CATV frequency allocation tables for further information as required.

The highest available RF channel number for the PCS400R is 135. Thus, to allocate all eight channels available for PCS400R RF output, the RF start channel must be set no higher than 128.

___ Find a location on the frequency spectrum that is free of existing noise.

Setup Information (Cont.)

Video Channel Assignments for RF Output (DVB-C)

Each input program is limited to one-half or one-third of the output channel bitrates (Mbps), which in turn are dependent on the modulation format. 256-QAM modulation supports up to 37.27 Mbps (6 MHz bandwidth), 45.05 Mbps (7 MHz bandwidth) or 50.87 Mbps (8 MHz bandwidth) per channel, and 64-QAM modulation supports up to 27.95 Mbps (6 MHz bandwidth), 33.79 Mbps (7 MHz bandwidth) or 38.15 Mbps (8 MHz bandwidth) per channel.

- ___ Create a channel assignment plan for the installation site, or modify an existing plan to incorporate the RF output of the PCS400R. Ensure that up to eight contiguous CATV channel frequencies are allocated for the PCS400R RF output. The PCS400R uses a 256-QAM or 64-QAM modulation format, thereby occupying approximately 48 MHz, 56 MHz, or 64 MHz (depending on channel bandwidth) of frequency spectrum.

The RF start channel frequency is user-assigned, in KHz, during system setup (in the Admin Client), and the remaining channel frequencies (up to seven) are then automatically assigned in accordance with the specified bandwidth. For example, if the RF start channel frequency assignment is 57000 KHz with a 7 MHz bandwidth, the seven remaining channel frequencies will be 64000 KHz, 71000 KHz, 78000 KHz, 85000 KHz, 92000 KHz, 99000 KHz, and 106000 KHz.

The highest available RF channel frequency for the PCS400R is 861000 KHz.

- ___ Find a location on the frequency spectrum that is free of existing noise.

Video Channel Assignments for RF Output (ISDB-T)

Each input program is limited to one-half or one-third of the output channel bitrates (Mbps). ISDB-T modulation supports up to 23.23 Mbps (6 MHz bandwidth) per channel.

- ___ Create a channel assignment plan for the installation site, or modify an existing plan to incorporate the RF output of the PCS400R. Ensure that up to two (Java application) or three (HTML application) contiguous CATV broadcast channels are allocated for the PCS400R RF output. The PCS400R occupies up to 18 MHz of frequency spectrum.

The RF start channel is user-assigned during system setup (in the Admin Client), and the remaining channels (up to one for the Java application or two for the HTML application) are then automatically assigned in accordance with the 6 MHz bandwidth. For example, if the RF start channel assignment is channel 7 on a server configured for the HTML application, the two remaining channels will be 8 and 9.

The data channel number must be between 7 and 69. Thus, for example, to allocate all three channels available for PCS400R RF output with the HTML application, the RF start channel must be set no higher than 67.

Note: The Pro:Centric server cannot generate channels 13 and 14 simultaneously. If you intend to configure more than one channel, set the data channel number from 7 to 12 (two channels) or 7 to 11 (three channels) or from 14 to 68.

- ___ Find a location on the frequency spectrum that is free of existing noise.

Setup Information (Cont.)

Video Channel Assignments for IP Output

Each IP stream is limited to 19.4 Mbps.

— The PCS400R outputs IPv4 multicast streams. Ensure the institution's IP network and room receivers support IPv4 multicast and that the network is capable of selectively routing multicast traffic. Refer to vendor equipment documentation for further information.

— Create a channel assignment plan for the installation site, or modify an existing plan to incorporate the IP output of the PCS400R. Ensure that up to 23 unused and unreserved IPv4 multicast addresses, within the designated range 224.0.0.0 to 239.255.255.255, are allocated for the PCS400R IP output.

The IP start channel is user-assigned in the Admin Client, and the remaining channel assignments are then automatically incremented. For example, if the IP start channel assignment is 227.0.0.40, the remaining channels will be 227.0.0.41, 227.0.0.42, etc. Since the first two streams are reserved for site data, the first video content channel in this scenario will be 227.0.0.42.

— Reserve one User Datagram Protocol (UDP) port for the multicast data streams. You can use the system default (1234) or another unassigned port number, for example, 50000, 50001, etc. The port must avoid conflict with other protocols in use.

Note: Refer to the IANA IPv4 Multicast Address Space Registry and/or the IANA Service Name and Transport Protocol Port Number Registry for further IP address/port information as required.

ASI Output (Optional)

ASI output supports up to 19.4 Mbps each for GEM and site data (total of 38.8 Mbps).

— If the system is using ASI output, install the modulator and upconverter that will receive the ASI output signal from the PCS400R. Refer to the manufacturer's documentation.

Rear and Front Panel Overviews

PCS400R Rear View

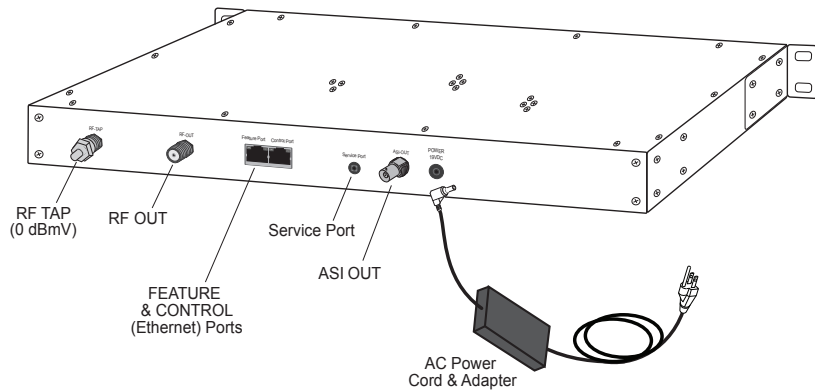

Disconnect Device

The AC mains plug is used as the disconnect device. The disconnect device must remain readily operable.



RF TAP Connector

Reserved for service technician use only. When not in use, this connector must remain terminated with attached terminator accessory.

PCS400R Front View

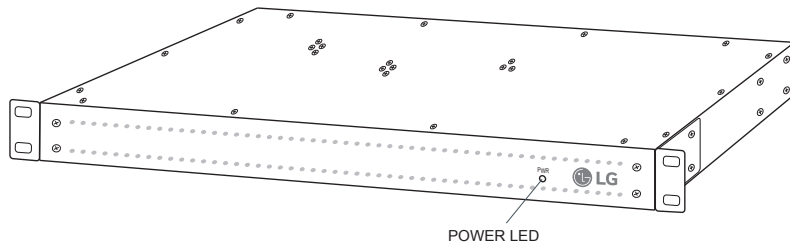

Ventilation

Air flow must not be obstructed. To ventilate the system normally and avoid overheating, leave at least 1 inch (2.5 cm) on each side (including top and bottom) of the PCS400R. Do NOT stack other equipment on the top of the PCS400R.



Screws with Lock Washers

Only qualified service personnel should handle and install the PCS400R. A series of screws with lock washers are used to secure the top and bottom covers of the PCS400R. Use caution when handling the unit as the lock washers may have rough edges. Do NOT run your fingers over the top and bottom covers of the unit.

Rack Installation

Typical Rack Installation

1. To avoid causing electrostatic (ESD) damage to the PCS400R during installation, attach an antistatic wrist strap to a properly grounded rack/object and put it on.
2. (Optional) As shipped, the PCS400R mounting brackets are attached flush with the front of the unit (see diagram a). If desired, the mounting brackets may be detached from the unit and reattached, for example, so that they are flush with the rear of the unit (see diagram b). If you wish to change the location/orientation of the mounting brackets, carefully remove each of the four (M4 x 10 mm) screws and attendant washers (one flat and one lock washer per screw) holding each bracket in place. Then, use the same screws and washers to reattach the mounting brackets in the desired location.
3. Carefully slide the chassis into a standard 19-inch equipment rack.
4. Use all four mounting screws to secure the chassis to the rack.

(a)

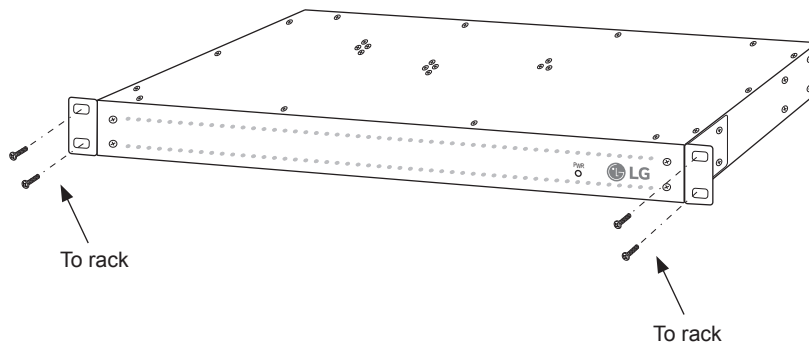

(b)

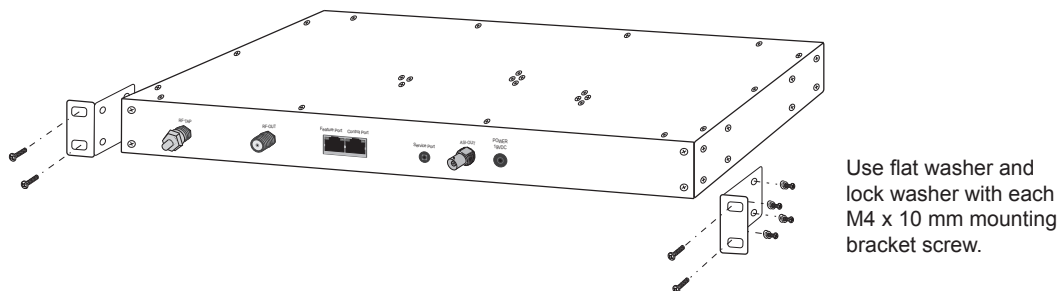

Rack Installation (Cont.)

Front View
of Rack Cabinet

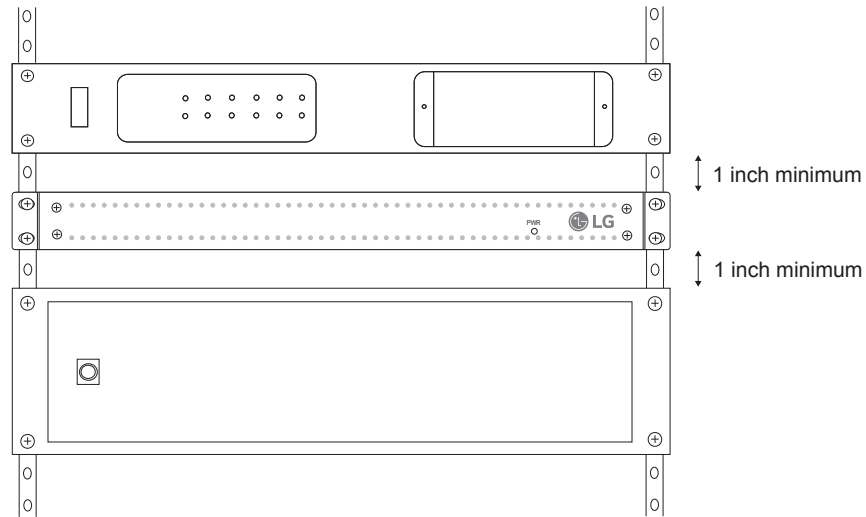

Rack-mount Considerations

A. Elevated Operating Ambient

If installed in a closed or multi-unit rack assembly, the operating ambient temperature of the rack environment may be greater than room ambient. Therefore, consideration should be given to installing the equipment in an environment compatible with the maximum ambient temperature (T_{ma}) specified by the manufacturer (see Specifications information in this document).

B. Reduced Air Flow

Installation of the equipment in a rack should be such that the amount of air flow required for safe operation of the equipment is not compromised. To ventilate the system normally and avoid overheating, leave at least 1 inch (2.5 cm) on each side (including top and bottom) of the PCS400R. Do NOT stack other equipment on the top of the PCS400R unit. Also, ensure that the unit's AC power adapter is never stacked or bundled with other AC power adapters. Each adapter should have adequate ventilation and should be isolated from other heat sources.

C. Circuit Overloading

Consideration should be given to the connection of the equipment to the supply circuit and the effect that overloading of the circuits might have on overcurrent protection and supply wiring.

D. Reliable Earthing

Maintain reliable earthing of rack-mounted equipment. Particular attention should be given to supply connections other than direct connections to the branch circuit (e.g., use of power strips).

E. Mains Outlet Earthing

The apparatus with Class I construction must be connected to a mains socket outlet with a protective earthing connection.

System Setup

Refer to the following diagrams, and complete the system installation as described on pages 17 to 21.

Caution: Do NOT make system connections until instructed to do so during the system installation procedure. In some instances, configuration steps must be performed before physical connections are made.

Typical Setup Diagram for PCS400R with ASI Output

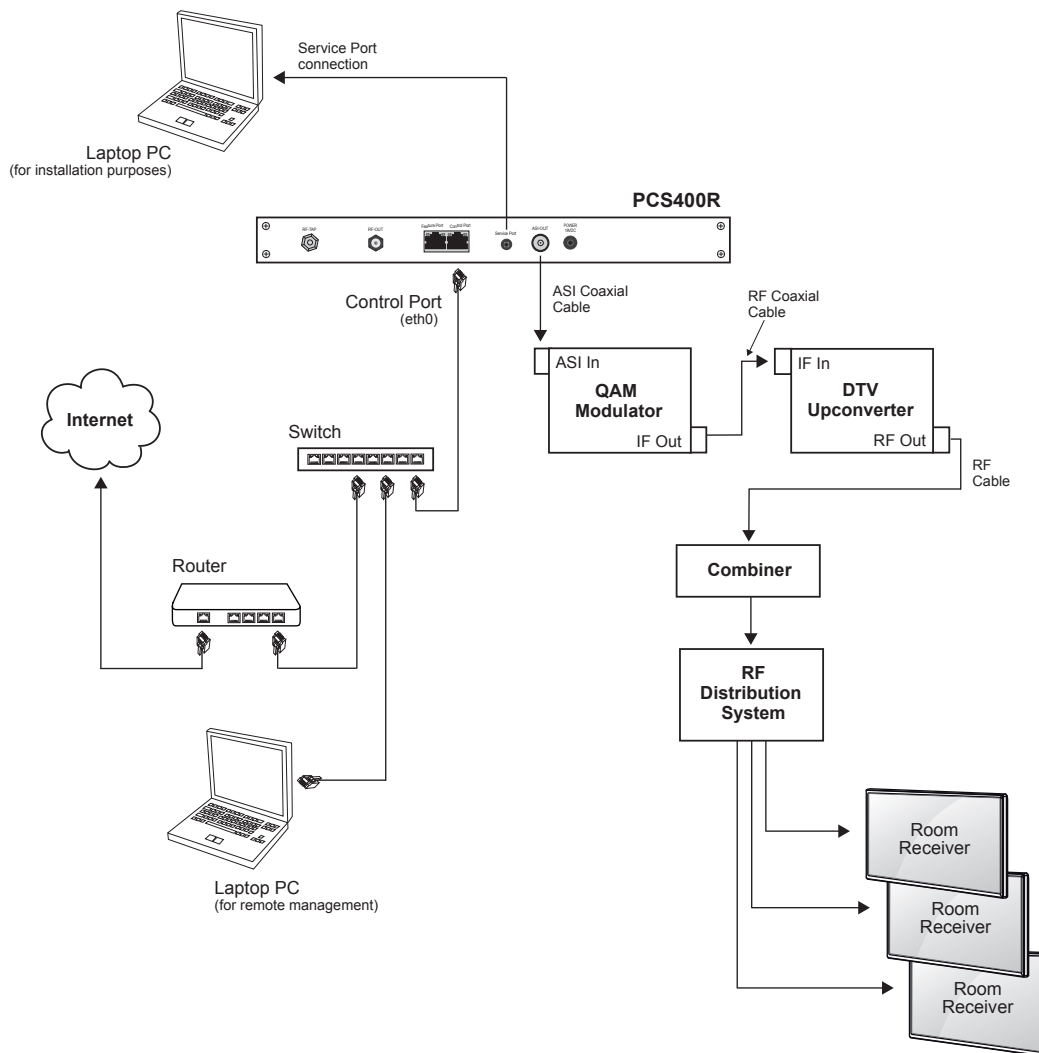

System Setup (Cont.)

Typical Setup Diagram for PCS400R with RF Output

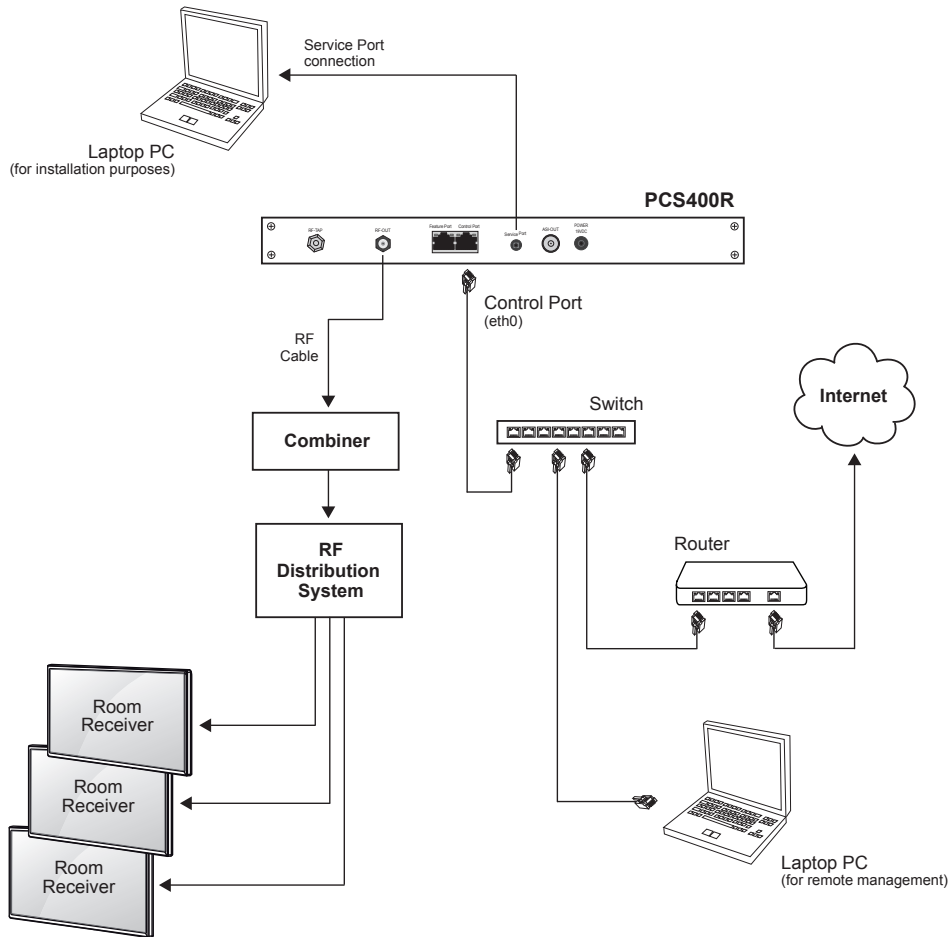

System Setup (Cont.)

Typical Setup Diagram for PCS400R with IP Output

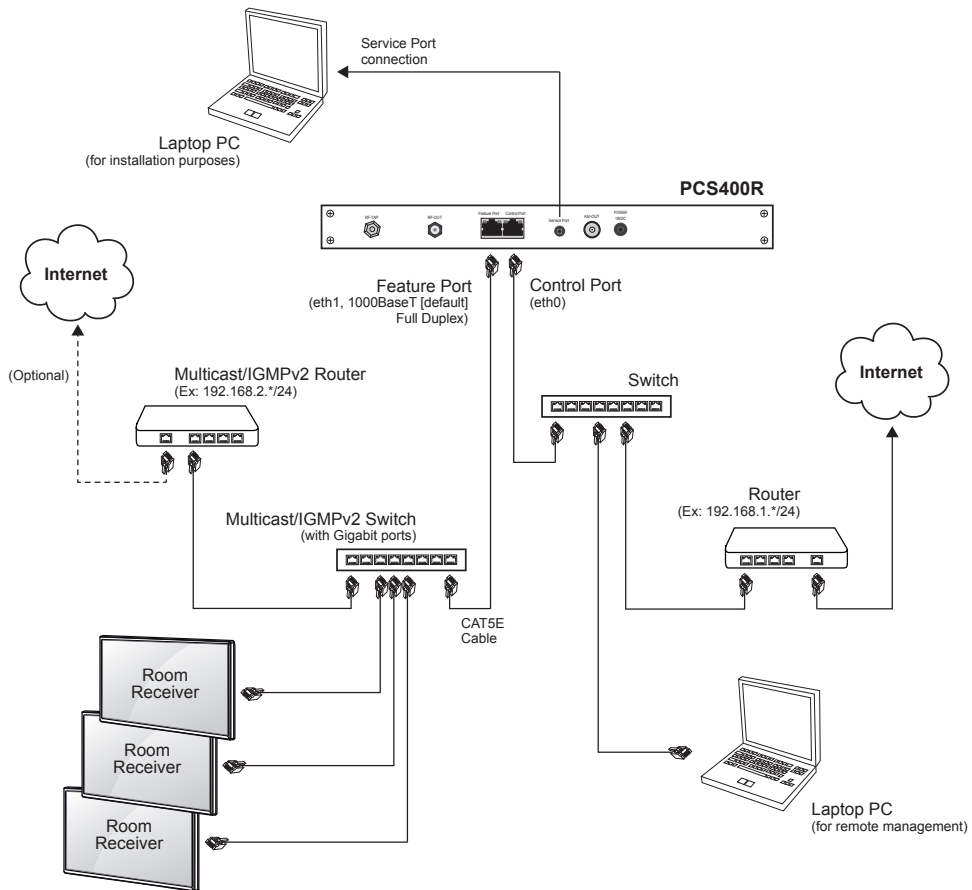

VPN Network Connections Overview

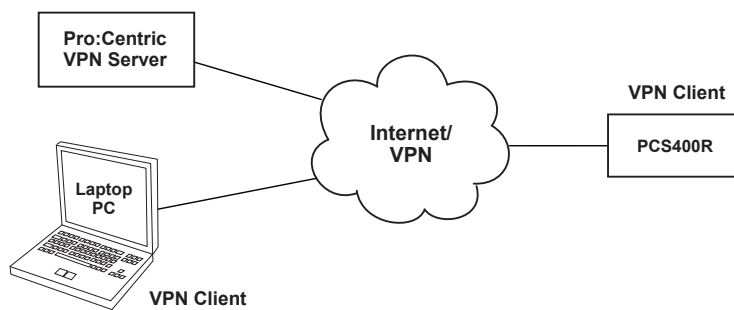

System Setup (Cont.)

Setting Up the Pro:Centric Network

This section describes how to complete the initial network configuration for the PCS400R. See also typical setup and VPN network connections diagrams above.

1. If your system is using ASI output, make the following connections; otherwise, go to step 2.
 - Connect a 75 ohm BNC-to-BNC coaxial cable between ASI OUT on the PCS400R and ASI IN on the modulator.
 - Connect an RF coaxial cable between IF OUT on the modulator and IF IN on the upconverter.

 **Note: The BNC cable must be less than 30 feet (9.2 meters) in length.**

2. To enable remote management, connect one end of a CAT5 RJ-45 Ethernet cable to the Control Port on the PCS400R rear panel, and connect the other end of the cable to the institution's network.
3. Connect the PCS400R power supply to the POWER connector on the PCS400R rear panel. Then, plug the AC power cord into a powered AC line receptacle. When power is applied, the PWR (Power) LED on the PCS400R front panel will initially flash red and then turn green (blinking during boot-up).

The boot-up process for the PCS400R may take several minutes. When boot-up is complete, the PWR LED on the PCS400R front panel will light continuously green.
4. Once the PWR LED is lit continuously (no longer blinking), use the FTDI TTL-232R-5V-AJ cable to connect a PC to the Service Port on the PCS400R rear panel.
5. Using HyperTerminal or an equivalent terminal emulation program on the PC, configure the serial port as follows: Bits per second/ baud = 115200; Data bits = 8; Parity = None; Stop bits = 1; Flow Control = None

Note: To avoid configuration errors, make sure the keyboard settings on the terminal emulator assign the backspace character to Ctrl + H (ASCII 8).

Once the connection is established, you should see a login prompt. (If the login prompt is not automatically displayed, press **Enter** to refresh the screen.)

6. At the `login as:` prompt, type **admin** and press **Enter**. Then, at the `password:` prompt, type **Password4Partners** (case-sensitive) and press **Enter**.

 **Note: After the initial system setup is complete, it is highly recommended that you change the admin user password from its default value. See "Change the Login Password" on page 32 for further information.**

The system will display a prompt for you to select the Pro:Centric portal application you will be using:

(Continued on next page)

System Setup (Cont.)

(Continued from previous page)

You must select a portal application to continue.

Available portal applications are:

- 1 pca (Java)
- 2 pcd (HTML)

Enter 1 or 2 to select a portal application:

7. Either:

- Type **1** and press **Enter** to select the Java application.
- Type **2** and press **Enter** to select the HTML application.

Note: Select the appropriate application based on the purchase order associated with this server. The software license specifies the Java or HTML application, and the application type must be set accordingly in this step.

Once you make your selection, the server will display confirmation before initiating a reboot, for example:

```
You selected the pcd (HTML) application
System will now reboot to run the selected application
```

8. When the reboot is complete, you should see a new login prompt. Log back in to the server (see step 6).

Once you are logged in, you will see a `Command >` prompt.

The next step describes how to set static IP addresses for the Control Port and/or Feature Port, if desired/applicable. The Control Port is used for remote management/communication purposes, while the Feature Port is designated for PCS400R IP output (not applicable if your system is using RF or ASI output). By default, both ports are configured for DHCP.

Note: You can press **Enter** at any PCS400R command prompt to view current menu, if desired.

Note: To view the server's current configuration settings, type **info** and press **Enter** at the `Command >` prompt. The System Information display will show the IP address that has been assigned to the Control Port (if the network is configured for DHCP) and the output configuration. See "View System Information" on page 24 for further information.

Note: If the Control Port network is configured for DHCP but the Control Port IP address is not displayed in the System Information display (see note above), refer to "Network Setup" troubleshooting information on page 40. If configured, the DHCP server should assign an IP address to the Control Port once the PCS400R successfully connects to the network.

(Continued on next page)

System Setup (Cont.)

(Continued from previous page)

9. (Optional) Set a static IP address for the Control Port and/or Feature Port.

Note: For detailed information on this step and additional screen samples, see “Modify Network Settings” on pages 25 to 28.

- a) At the `Command >` prompt, type **setip** and press **Enter**.

TCP/IP configuration is performed in the CentOS Network Manager TUI (text-based user interface). The system will display the Network Manager menu, for example:

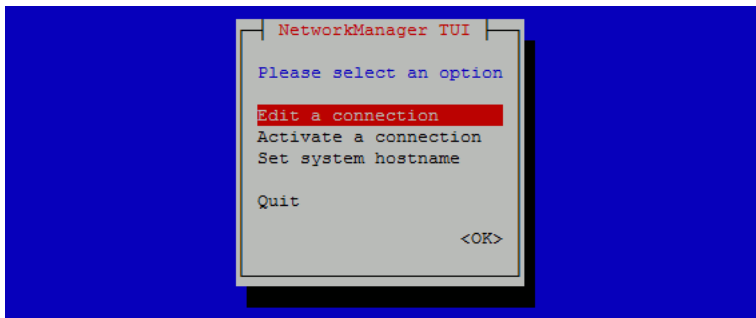

- b) Select/highlight **Edit a connection** and press **Enter**.
- c) In the next screen, select/highlight the port you wish to configure and press **Enter**.
- d) With the Edit Connection screen for the selected port on display, add the appropriate IP address in the format `xxx.xxx.xxx.xxx/xx`, where the last two digits (after the forward slash) identify the network mask bits for the IP address.

Also, add the gateway, and DNS IP addresses in the format `xxx.xxx.xxx.xxx`.



Note: In order to avoid a service interruption, do not modify any of the other fields in the Edit Connection screen. In particular, do **NOT** modify the data in the Profile Name and Device fields.



Note: The Feature Port IP address **MUST** be on a different subnet than the Control Port IP address. Also, while either IPv4 or IPv6 is supported for the Control Port, the Feature Port must be configured on an IPv4 network.

- e) When you are finished with network configuration for the selected port, select/highlight **<OK>** at the bottom right of the Edit Connection screen and press **Enter**.
- f) Repeat steps (c) to (e), as required, to complete configuration for the second port.
- g) When you are finished with port configuration, select/highlight **<Quit>** at the bottom right of the port selection screen and press **Enter** to return to the Network Manager menu. To exit the Network Manager and return to the `Command >` prompt, select **Quit** and press **Enter**.

(Continued on next page)

System Setup (Cont.)

(Continued from previous page)

Note: Review the configuration data for each port carefully before you confirm the settings. Ensure each of the addresses was entered correctly.

Note: You may also edit the host name from the Network Manager menu, if desired. See “Modify the Server Host Name” on pages 28 to 29 for further information. Avoid using spaces or special characters, such as ?, -, etc., in the host name.

10. (Optional) Set the time zone and/or the date and time on the PCS400R.

By default, the PCS400R is synchronized with an NTP server and configured for the US Eastern time zone. If the PCS400R is connected to the Internet, the NTP client will periodically update the time setting on the PCS400R. You can set the time zone as required. If the PCS400R is not connected to the Internet, you also have the option to specify date and time data manually.

Use the PCS400R “tz” and/or “time” commands (available from the `Command >` prompt) and follow the system prompts to set the time zone and/or date and time on the PCS400R, as necessary. See “Set the Time Zone” on pages 29 to 31 and/or “Set the Date and Time” on pages 31 to 32 for further information.

Note: If you changed the time zone, you will be prompted to reset the system. Continue with step 11.

11. If you made any configuration changes in steps 9 or 10, reset the PCS400R: At the `Command >` prompt, type **reset** and press **Enter**.

The reset process may take several minutes, after which the PCS400R resumes normal operation.

12. Make the appropriate connection to the RF distribution system or IP distribution network depending on the PCS400R output option to be used.

- ASI output: Connect the RF output on the upconverter to the RF distribution center combiner, and balance the RF signal so that the Pro:Centric signal level at the TV(s) is between 0 to +7 dBmV.
- RF output: Connect RF OUT on the PCS400R to the RF distribution center combiner, and balance the RF signal so that the Pro:Centric signal level at the TV(s) is between 0 to +7 dBmV.
- IP output: Connect a CAT5E or better Ethernet cable between the Feature Port on the PCS400R rear panel and the institution’s IP distribution network.



Caution (ASI/RF Output only): For proper system performance, the Pro:Centric signal level at the TV input (ANTENNA IN) must be between 0 to +7 dBmV. Note that additional equipment may be required to adjust the signal level.

(Continued on next page)

System Setup (Cont.)

(Continued from previous page)



Caution: When not in use, the RF TAP (0 dBmV) connector must remain terminated with attached terminator accessory.

The remainder of the system setup—configuration of ASI, RF, or IP output parameters, video playout settings, Pro:Centric Channel Map, etc.—is performed in the Admin Client that is appropriate for your system (based on your selection in step 7 of the procedure above). Refer to either the *Pro:Centric Server Admin Client User Guide* (Java application) or the *Pro:Centric Direct Admin Client User Guide* (HTML application), as applicable, for further information.

Note: By default, the server output is enabled for 256-QAM-B modulation (RF output), with the data channel set to 75.

PCS400R Configuration Options

Network and Communication Setup

This section describes PCS400R communication options for configuration purposes.



Note: Before you proceed with any additional configuration, the PCS400R software should be installed and configured as described in the setup procedure on pages 17 to 21.

Also note that configuration updates periodically require that you reset the PCS400R. Make sure to reset the unit when directed to do so.

There are two typical options for communicating with the PCS400R:

- Use an SSH client to communicate with the PCS400R via a command line interface. If necessary, consult the network administrator to obtain the IP address that has been assigned to/configured for the PCS400R's Control Port.
- To establish a direct connection to the PCS400R, connect a PC to the PCS400R using the FTDI TTL-USB cable (P/N TTL-232R-5V-AJ). Plug the USB end of the cable into an open USB port on your PC. If necessary, install the device driver. Plug the other end of the cable into the Service Port jack on the PCS400R rear panel.

Using HyperTerminal or an equivalent terminal emulation program on the PC, configure the serial port as follows:

- Bits per second/ baud = 115200
- Data bits = 8
- Parity = None
- Stop bits = 1
- Flow Control = None

Note: To avoid configuration errors, make sure the keyboard settings on the terminal emulator assign the backspace character to Ctrl + H (ASCII 8).

You will need to know the "admin" user password in order to log in to the command line interface. The default admin user password is "Password4Partners" (case-sensitive). If necessary, for example, if the password has been changed from its default value, consult the system administrator to obtain the current admin user password.

Note: If you want to connect a PC directly to the PCS400R Control Port using an Ethernet CAT5E cable, in order for communication to be established, the PCS400R's IP address must be on the same subnet as the PC's IP address.

PCS400R Configuration Options (Cont.)

Log In to the PCS400R and Access the Main Menu

Note: The PCS400R must be connected to an IP network for SSH client access. For direct access to the PCS400R Service Port, use the FTDI TTL-USB cable (P/N TTL-232R-5V-AJ). See also “Network and Communication Setup” above for further information.

1. Establish communication with the PCS400R using an SSH client or via a direct connection to the PCS400R Service Port.

Once communication is established, you should see a login prompt. (If the login prompt is not automatically displayed, press **Enter** to refresh the screen.)

2. At the `login as:` prompt, type **admin** and press **Enter**.
3. At the `Password:` prompt, type the admin password and press **Enter**.
4. At the `Command >` prompt, either:
 - Press **Enter** to display the PCS400R Main Menu (see example below).
 - Type the desired command and press **Enter**.

The following sections describe each of the configuration commands.

Note: You can always press **Enter** at the `Command >` prompt to display the PCS400R Main Menu.

Example: PCS400R Main Menu

```
-----  
Main Menu  
-----  
  info          System information  
  setip         TCP/IP Setup Menu  
  tz            Timezone setup  
  time         Time setup  
  pwd          Change password  
  portal       Select the portal application  
  monitor     System monitor  
  ping        Send ICMP ECHO_REQUEST to network hosts  
  update      Update  
  vpn         VPN setup  
  shut        Shutdown the system  
  reset       System reset  
  reinstall   Return to factory configuration  
  exit        End the session  
  
Command >
```

PCS400R Configuration Options (Cont.)

View System Information

1. Log in to the PCS400R as described on the previous page.
2. At the `Command >` prompt, type **info** and press **Enter**.

The System Information display identifies important information about the PCS400R, including the unit serial number, hardware ID (firmware version), software versions, MAC addresses, IP addresses, etc., for example:

```
PCS400R Pro:Centric Server vx.x-xxxx/y.y.y.yyyyy
Copyright (c) 2018 LG Electronics U.S.A., Inc.

SN:                601-12480013
Hardware ID:       1
FPGA version:     802
BIOS version:     116
BIOS vendor:      PCS400v3
CPU SN:           000002703544
OS version:       Linux 3.10.0-327.e17.x86_64
OS release:       #1 SMP Thu Nov 19 22:10:57 UTC 2015
Ctrl MAC:         00:13:95:21:a2:7d
Ctrl IP:          10.1.2.3
Ctrl IP V6:       n/a
Feat MAC:         00:0C:63:40:47:db
Feat IP:          192.168.20.120
Feat IP V6:       n/a
VPN IP:           n/a
RF config:        Mode 3, 256-QAM-B, RF: 6 MHz, 5.36 MSps, ASI: 38.81 Mbps
RF channel:       75
Channels:         1
Docker vers:     17.09.0-ce, build afdb6d4
Portal app:       pcd (HTML)
Local time:      Wed Nov 21 14:42:02 EDT 2018
```

where `x.x-xxxx` is the version and build number of the HTML application and `y.y.y.yyyyy` is the version and build number of the Java application.

Note: If RF output is configured for DVB-C modulation, the display will identify the RF frequency (in KHz) in place of the RF channel. If IP output is configured, the display will identify the multicast IP address in place of the RF fields.

It is recommended that you record this information for future reference. If you find it necessary to call customer service or engineering support, please have this information available.

PCS400R Configuration Options (Cont.)

Modify Network Settings

This section describes how to modify the network settings of the PCS400R Ethernet ports. The Control Port is used for remote management/communication purposes, while the Feature Port is designated for PCS400R IP output.

1. Log in to the PCS400R as described on the previous page.
2. At the `Command >` prompt, type **setip** and press **Enter**.

The system will display the Network Manager menu.

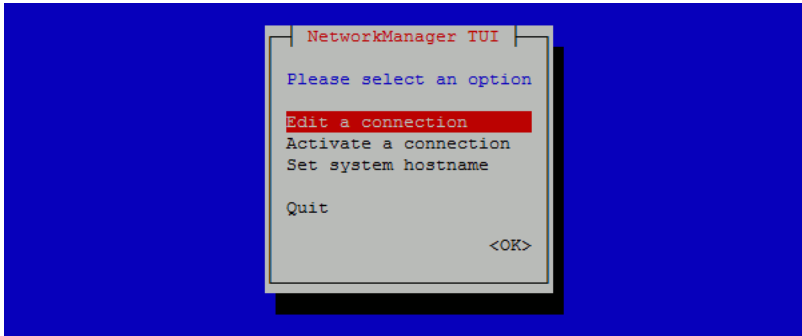

3. Select/highlight **Edit a connection** and press **Enter** to modify the IP configuration of either the Control Port or the Feature Port.

Note: To exit the Network Manager and return to the Main Menu prompt without modifying any settings, select **Quit**. You may also modify the server's host name from the Network Manager. See "Modify the Server Host Name" on pages 28 to 29 for further information.

4. In the next screen, select/highlight the port profile to modify, and then press **Enter**.

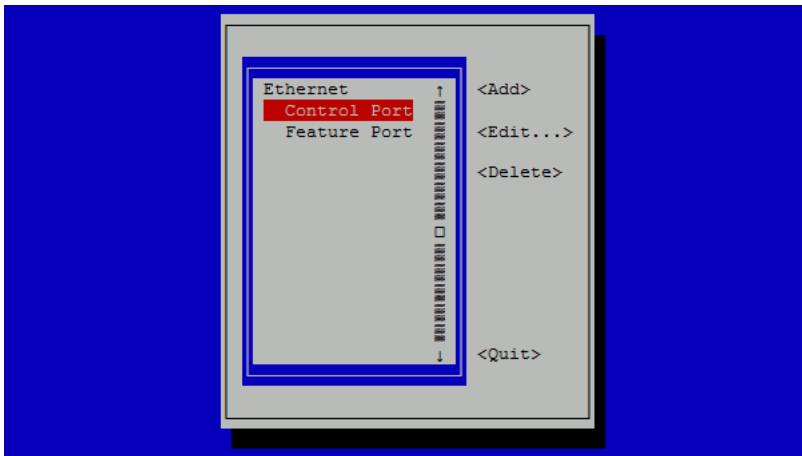



(Continued on next page)

PCS400R Configuration Options (Cont.)

(Continued from previous page)

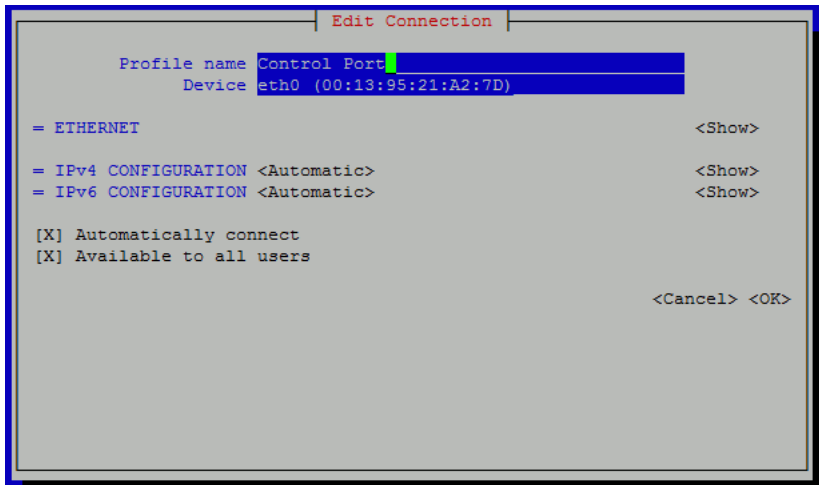
Once you select a port, the Edit Connection screen for that port will be displayed, for example:



 **Note:** Steps 5 to 9 identify all fields that may require modification for the purposes of the Pro:Centric network. In order to avoid a service interruption, do not modify any of the other fields in the Edit Connection screen. In particular, do NOT modify the data in the Profile Name and Device fields.

 **Note:** The Feature Port IP address MUST be on a different subnet than the Control Port IP address. Also, while either IPv4 or IPv6 is supported for the Control Port, the Feature Port must be configured on an IPv4 network.

- To change the port configuration from Automatic to Manual or vice versa, select/highlight the appropriate IP Configuration field (IPv4 or IPv6—see also note above) and press **Enter**. Then, select the appropriate option (**Automatic** or **Manual**) from the drop-down menu.

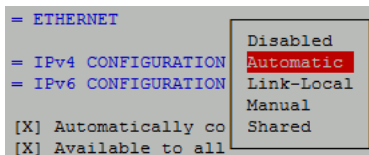

- The next step depends on your selection in the previous step.
 - If you selected Automatic, go to step 9.
 - If you selected Manual, continue with step 7.

(Continued on next page)

PCS400R Configuration Options (Cont.)

(Continued from previous page)

7. If you are configuring static (i.e., manual) settings, select/highlight **<Show>** at the right of the IP Configuration field and press **Enter** to view the expanded configuration fields.

```
IPv4 CONFIGURATION <Manual> <Hide>
  Addresses <Add...>
  Gateway
  DNS servers <Add...>
  Search domains <Add...>
```

8. Complete the following configuration:
 - Select/highlight **<Add...>** and press **Enter** in the Addresses field. Then, type the appropriate IP address in the format xxx.xxx.xxx.xxx/xx, where the last two digits (after the forward slash) identify the network mask bits for the IP address.Also, type the gateway IP address (in the format xxx.xxx.xxx.xxx) in the Gateway field.

```
IPv4 CONFIGURATION <Manual> <Hide>
  Addresses <Add...> <Remove>
  Gateway
  DNS servers <Add...>
  Search domains <Add...>
```

Note: If you do not specify the network mask bits in the port's IP address, as indicated above, the system will not create a local route over the network interface (unless the interface is used as the system's default route).

- Select/highlight **<Add...>** and press **Enter** in the DNS Servers field, and type the primary DNS IP address (in the format xxx.xxx.xxx.xxx). As required, select **<Add...>** again and type the secondary DNS IP address.

```
IPv4 CONFIGURATION <Manual> <Hide>
  Addresses <Add...>
  Gateway
  DNS servers <Add...> <Remove>
  Search domains <Add...>
```

9. (Recommended) Change the unused port configuration from "Automatic" to "Ignore." For example, for the Feature Port, select/highlight the IPv6 Configuration field and press **Enter**. Then, select **Ignore** from the drop-down list of options.
10. When you are finished, select/highlight **<OK>** at the bottom right of the Edit Connection screen and press **Enter**.

(Continued on next page)

PCS400R Configuration Options (Cont.)

(Continued from previous page)

11. Repeat steps 4 to 10 for the second port as required. When you are finished with port configuration, select/highlight **<Quit>** at the bottom right of the port selection screen and press **Enter** to return to the Network Manager menu. To exit the Network Manager and return to the Main Menu prompt, select **Quit** and press **Enter**.
12. If you changed the port configuration, you will need to reset the system. If you are ready to reset the system immediately, at the `Command >` prompt, type **reset** and press **Enter** (see “Reset the System” on page 38 for further information).

Note: If you intend to modify additional configuration settings during the current session, you may wait until all changes are complete before you reset the system.

Modify the Server Host Name

This option enables you modify the PCS400R host name.

1. Log in to the server as described on page 23.
2. At the `Command >` prompt, type **setip** and press **Enter**.

The system will display the Network Manager menu, for example:

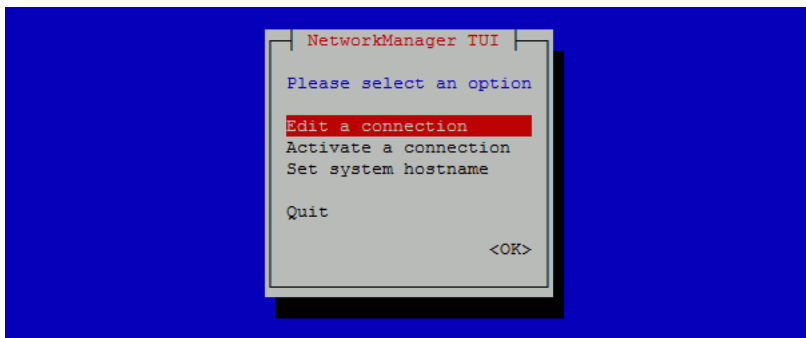

3. Select/highlight **Set system hostname** and press **Enter**.

Note: To exit the Network Manager and return to the Main Menu prompt without modifying any settings, select **Quit**. You may also modify the Control and/or Feature Port configuration from the Network Manager. See “Modify Network Settings” on pages 25 to 28 for further information.

4. The Hostname field in the Set Hostname screen shows the current host name. Modify the host name as required (avoid using spaces or special characters, such as ?, -, etc.) and then press **Enter**.

(Continued on next page)

PCS400R Configuration Options (Cont.)

(Continued from previous page)

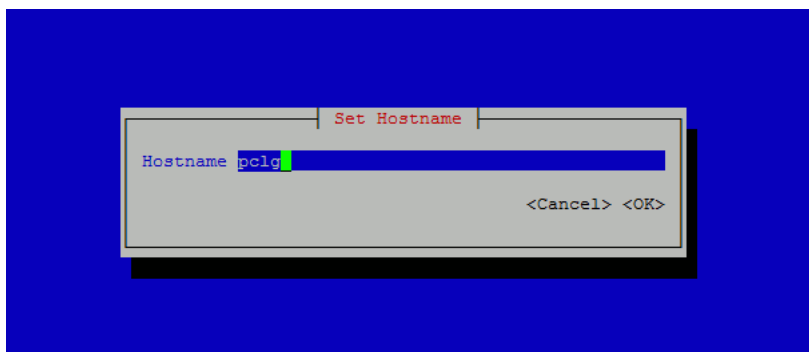

5. At the prompt for confirmation, press **Enter**.



6. If you changed the host name, you will need to reset the system. If you are ready to reset the system immediately, at the `Command >` prompt, type **reset** and press **Enter** (see "Reset the System" on page 38 for further information).

Note: If you intend to modify additional configuration settings during the current session, you may wait until all changes are complete before you reset the system.

Set the Time Zone

1. Log in to the PCS400R as described on page 23.
2. At the `Command >` prompt, type **tz** and press **Enter**.

The system displays the current time zone information for the PCS400R and prompts you to specify whether or not you wish to change the time zone.

(Continued on next page)

PCS400R Configuration Options (Cont.)

(Continued from previous page)

```
Current time zone is: America/New York
Change the time zone? [y/n]:
```

3. Either:

- Type **n** and press **Enter** to return to the Main Menu `Command >` prompt without changing the current time zone.
- Type **y** and press **Enter** to change the time zone. Then, continue with step 4.

4. The system will display the following prompt for a location, followed by a list of options:

```
Please identify a location so that time zone rules can be set correctly.
Please select a continent or ocean.
```

At the `#?` prompt, type the number that corresponds to the appropriate option for your location, and then press **Enter**.

5. The system will display the following prompt for a country, followed by a list of options:

```
Please select a country.
```

At the `#?` prompt, type the number that corresponds to the appropriate option for your country, and then press **Enter**.

6. The system will display the following prompt for a region, followed by a list of options:

```
Please select one of the following time zone regions.
```

At the `#?` prompt, type the number that corresponds to the appropriate option for your region, and then press **Enter**.

After you specify the time zone region, the system displays an overview of your location selections and prompts for confirmation, for example:

```
The following information has been given:
```

```
United States
Central Time
```

```
Therefore TZ='America/Chicago' will be used.
```

```
Local time is now:      Wed Nov 21 16:23:10 CDT 2018.
```

```
Universal Time is now: Wed Nov 21 22:23:10 UTC 2018.
```

```
Is the above information OK?
```

```
1) Yes
```

```
2) No
```

```
#?
```

(Continued on next page)

PCS400R Configuration Options (Cont.)

(Continued from previous page)

7. Either:

- Type **1** and press **Enter** if the information in the display is correct. The system will confirm the setting and then prompt you to reset the PCS400R:

```
Time zone has been set. Please reset the board.
```

Continue with step 8.

- Type **2** and press **Enter** to return to the initial location prompt and reset the time zone (repeat this procedure from step 4).

8. If you are ready to reset the system immediately, at the `Command >` prompt, type **reset** and press **Enter** (see “Reset the System” on page 38 for further information).

Note: If you intend to modify additional configuration settings during the current session, you may wait until all changes are complete before you reset the system.

Set the Date and Time

By default, the PCS400R is synchronized with an NTP server and configured for the US Eastern time zone. If the PCS400R is connected to the Internet, the NTP client will periodically update the time setting on the PCS400R. If the PCS400R is not connected to the Internet, you also have the option to specify date and time data manually. Refer to “Set the Time Zone” above for information on setting the time zone.

1. Log in to the PCS400R as described on page 23.

2. At the `Command >` prompt, type **time** and press **Enter**.

```
The system will display the current time (for example: Current time: 2018-11-21  
15:45:44) and then initiate a series of prompts to enable you to set the time.
```

3. At each of the following prompts, type the year, month, and day, respectively. Note that all three of these fields require numerical values. Press **Enter** after each entry.

If applicable, you can also press **Enter** at each prompt to accept the default value in square brackets.

```
Enter new year [2018]>  
Enter new month [11]>  
Enter new day [21]>
```

4. At each of the following prompts, type the hour and minute, respectively. Note that the hour should be entered in 24-hour format. Press **Enter** after each entry.

(Continued on next page)

PCS400R Configuration Options (Cont.)

(Continued from previous page)

If applicable, you can also press **Enter** at each prompt to accept the default value in square brackets.

```
Enter new hour (0-23) [15]>
```

```
Enter new minute [45]>
```

Once you enter the minute value, the system will display the new time and then prompt for confirmation, for example:

```
New time: 2018-16-21 15:46:00
```

```
Apply? [y/n]:
```

5. Either:

- Type **y** and press **Enter** to apply the new time configuration. The system will display confirmation, for example: `New time is set`
- Type **n** and press **Enter** to return to the `Command >` prompt without changing the time configuration.

Change the Login Password

For security purposes, it is recommended that the admin user login password be unique to the system. Note that the login password is case-sensitive.

1. Log in to the PCS400R as described on page 23.
2. At the `Command >` prompt, type **pwd** and press **Enter**.

The system prompts for the current admin user password:

```
Changing password for admin
```

```
Old password:
```

3. Type the current password and press **Enter**. The system will then prompt you to type and retype the new password:

```
New password:
```

```
Retype password:
```

4. Type and then retype the new password at the prompts. Press **Enter** after each entry.

Once you complete the Password fields successfully, the system displays confirmation:

```
Password for admin changed by admin.
```

PCS400R Configuration Options (Cont.)

Change the Portal Application

This option enables you to change the portal application (Java or HTML), if necessary.



Caution: This option will create a temporary system interruption and should be used only when necessary. After you complete the procedure below, you must perform a number of additional steps in the appropriate Admin Client (i.e., the Admin Client for the new application) in order for portal functionality to be initiated. Software feature licensing, output configuration, and portal configuration are not ported from one application to the other.

1. Log in to the PCS400R as described on page 23.
2. At the `Command >` prompt, type **portal** and press **Enter**.

The system prompts for confirmation that you wish to make a change, for example:

```
The system is configured to use the pcd (HTML) portal application.
Do you wish to change the portal application? [y/n]:
```

3. Either:

- Type **y** and press **Enter** to continue. The system will display the available applications, followed by a prompt for a selection:

```
Available portal applications are:
```

- 1) pca (Java)
- 2) pcd (HTML)

```
Select a new portal application [2]:
```

Continue with step 4.

- Type **n** and press **Enter** to return to the Main Menu without changing the portal application.

4. At the prompt to select a new portal application, either:

- Type **1** and press **Enter** to select the Java application.
- Type **2** and press **Enter** to select the HTML application.

Note: Select the appropriate application based on the purchase order associated with this server. The software license specifies the Java or HTML application, and the application type must be set accordingly.

Once you make your selection, the server will display confirmation and prompt you to reboot the system, for example:

```
Successfully set to pca (Java) portal application
```

```
You must reset the system now.
```

```
Are you sure you want to reset the system? [y/n]:
```

(Continued on next page)

PCS400R Configuration Options (Cont.)

(Continued from previous page)

5. Either:

- Type **y** and press **Enter** to initiate an immediate reset of the PCS400R. The reset process may take several minutes, after which the system resumes normal operation.
- Type **n** and press **Enter** to return to the Main Menu without resetting the system at the current time; however, note that you must eventually reset the system in order to apply the new portal application configuration. See “Reset the System” on page 38 when you are ready to reset the system.

Note: If you intend to modify additional configuration settings during the current session, you may wait until all changes are complete before you reset the system.

The remainder of the new portal application setup—configuration of feature set, output parameters, video playout settings, Pro:Centric Channel Map, customized portal interactive menus, etc.—is performed in the appropriate Admin Client, as indicated at the beginning of this section. Refer to either the *Pro:Centric Server Admin Client User Guide* (Java application) or the *Pro:Centric Direct Admin Client User Guide* (HTML application), as applicable, for further information.



Caution: When your Admin Client portal configuration activities are complete, you must reset the server to activate the new application configuration.

Monitor the System

This option enables you to view dynamic system streaming data.

1. Log in to the PCS400R as described on page 23.
2. At the `Command >` prompt, type **monitor** and press **Enter** to display the current system data. See example on following page.
3. The system data will refresh every second. When you are finished monitoring streaming data, press **Enter** to stop the system monitor and return to the `Command >` prompt.

The system monitor display shows streaming data for each of the active video programs. The first column in the display shows the channel slot numbers for which video playlists can be defined. Slots 1 and 2 are reserved for GEM/site data and Slot 3 is unused (and is not shown in the display). On servers configured with the Pro:Centric Java application, it is possible to add a site video to Slot 2, and so for these systems, Slot 2 will appear in the system monitor display. On the other hand, it is not possible to add a site video to Slot 2 on servers that are configured with the Pro:Centric Direct HTML application, and so for these systems, Slot 2 will not appear in the system monitor display.

The system monitor example below shows data for a system that is configured for QAM-B RF output with the Pro:Centric Direct HTML application.

(Continued on next page)

PCS400R Configuration Options (Cont.)

(Continued from previous page)

Note: Output parameters are configured in the Admin Client. Refer to either the *Pro:Centric Server Admin Client User Guide* (Java application) or the *Pro:Centric Direct Admin Client User Guide* (HTML application), as applicable, for further information.

Example: System Monitor Display (QAM-B RF Output, HTML Application)

SYSTEM MONITOR

Date: 2018-11-21 16:44:27
SN: 401-12080008
Version: 1.1
Output: RF_QAM256_6M
Pg/RF: 2

Bitrates (Mbps):

Slot	Content	Secs	Mbit	Pct	RF Out
1	GEM Data	685	8.9	-	75-1
4	Video1.ts	6	5.1	1	76-1 :)
5	Video2.trp	205	4.6	78	76-2 :)
7	Video3.ts	40	4.2	12	77-1 :)
8	Video4.trp	172	2.7	66	77-2 :)
10	Video5.ts	12	3.5	3	78-1 :)
11		-	0.0	-	78-2
13	Video6.ts	171	4.7	94	79-1 :)
14		-	0.0	-	79-2
16		-	0.0	-	80-1
17		-	0.0	-	80-2
19		-	0.0	-	81-1
20		-	0.0	-	81-2
22		-	0.0	-	82-1
23		-	0.0	-	82-2

Press <Enter> key to exit the monitor

Send Ping Commands to Network Hosts

This option enables you to ping network hosts for troubleshooting purposes. Multiple data variables (flags) are available, as described below.

1. Log in to the server as described on page 23.
2. At the `Command >` prompt, you can either:

(Continued on next page)

PCS400R Configuration Options (Cont.)

(Continued from previous page)

- Type **ping destination**, where *destination* is the IP address or domain name of the network host, and then press **Enter** to ping the desired network host without any ping option flags.
The system will continue to send ping messages and display data until you press **Enter**.
- Type a ping command with flags (see examples below) and press **Enter** to collect specific data. Each flag name and input should be preceded and followed by a space, as shown in the Ping Commands With Flags example below.
If you did not specify the number of messages to send, the system will continue to send ping messages and display data until you press **Enter**.
- Type **ping** and press **Enter** to display information on ping command options. See Ping Command Usage Information example below.

3. (Unlimited messages only) When you are finished monitoring ping data, press **Enter** to stop the ping messages and return to the `Command >` prompt.

Once the ping messages are stopped (either manually via “Enter” press or via a Count flag), the system will display a summary of the ping statistics.

Example: Ping Command Usage Information

```
Usage: ping <destination> [ COUNT c ] [ SIZE s ] [ TTL t ] [ INTERFACE i ]  
Send ICMP ECHO_REQUEST messages to the specified address.
```

Optional flags:

```
  COUNT c      is the number of messages to send, default is unlimited  
  SIZE  s      is the number of data bytes, default is 50  
  TTL   t      is the IP packet's TTL value  
  INTERFACE i is the interface to send from, such as eth0 or eth1
```

Flag names may be shortened, e.g. you may type `t` instead of `TTL`.

All options are limited to the set of alphanumeric characters and dot, hyphen, and underscore: `a-z A-Z 0-9 . - _`

Command >

Example: Ping Commands With Flags

Note: Ping commands are not case-sensitive; however inputs are limited to alphanumeric characters (Aa, Bb, Cc, 1, 2, 3, etc.) and the dot, hyphen, and underscore (., -, and _) characters.

```
ping 1.2.3.4 c 2  
ping 1.2.3.4 c 4 i eth0  
ping 1.2.3.4 c 2 s 20 t 3
```

PCS400R Configuration Options (Cont.)

Update the PCS400R Operating System

This option is only applicable for the Java portal application. It enables you to update the PCS400R operating system via the Ethernet.



Caution: Do NOT initiate simultaneous menu sessions while a software update is in progress. Doing so may interfere with the active process and may corrupt the system configuration and/or cause the PCS400R to cease normal operation.

The appropriate update file must be provided by LG; the system will not download an improper file.

1. Log in to the PCS400R as described on page 23.
2. At the `Command >` prompt, type **update** and press **Enter**.
3. At the `Enter update filename:` prompt, type in the software update filename and press **Enter**.

The system will initiate the download and confirm progress, for example:

```
Downloading file: pcs400r_app_xxxx.upd
```

4. When the update is successfully completed, reset the system (see “Reset the System” on page 38 for further information).

Update the VPN Setup

This option is only applicable for the Java portal application. It enables you to update the VPN client via a serial link to the PCS400R.

The appropriate update file must be provided by LG; the system will not transfer an improper file.

1. Log in to the PCS400R as described on page 23.
2. At the `Command >` prompt, type **vpn** and press **Enter**.
3. At the `Send VPN client file using Xmodem ...` prompt, transfer the new VPN client file using Xmodem protocol. For example, in HyperTerminal, select **Transfer** and then **Send File...** In the Send File window, enter or select the appropriate filename in the Filename field, and select **Xmodem** in the Protocol field.

The update process may take several minutes. The system will display progress messages as well as the result of the update process.

4. When the update is successfully completed, reset the system (see “Reset the System” on page 38 for further information).

PCS400R Configuration Options (Cont.)

Shut Down the System

This command allows you to shut down the system in an orderly manner. Use this command to shut down the PCS400R, for example, if you intend to physically move the unit from one location to another. It is also recommended that you run this command from the PCS400R Service Port in order to track detailed shutdown log messages.

Note: Once you use this command, you must remove power from (i.e., unplug) the unit and then plug the AC power cord back into a powered AC line receptacle when you are ready to restart the server. It is not possible to restart the server remotely.

1. Log in to the PCS400R as described on page 23.
2. At the `Command >` prompt, type **shut** and press **Enter**.

The system will prompt for confirmation:

```
Are you sure you want to shut down the system? [y/n]:
```

3. Either:
 - Type **y** and press **Enter** to shut down the system immediately. The shutdown typically takes about a minute. When the PCS400R is in its shutdown state, the front panel LED will blink steadily green.
 - Type **n** and press **Enter** to return to the Main Menu without shutting down the system.

Reset the System

1. If not already logged in, log in to the PCS400R as described on page 23.
2. At the `Command >` prompt, type **reset** and press **Enter**.

The system will prompt for confirmation:

```
Are you sure you want to reset the system? [y/n]:
```

3. Either:
 - Type **y** and press **Enter** to initiate an immediate reset of the PCS400R. The reset process may take several minutes, after which the system resumes normal operation.
 - Type **n** and press **Enter** to return to the Main Menu without resetting the system.

Reinstall the Factory Configuration

This option reinstalls the Pro:Centric carousels to their factory default configuration, which may be useful for recovering from a system interruption.



Caution: This command removes portal content, media files, etc. After you run the command, TVs/STBs will no longer receive application downloads until you rebuild the application/re-add media files.

(Continued on next page)

PCS400R Configuration Options (Cont.)

(Continued from previous page)

Note: This command will not affect the server's network configuration and also preserves the feature set, if installed.

1. Log in to the PCS400R as described on page 23.
2. At the `Command >` prompt, type **reinstall** and press **Enter**.

The system will display a warning and then prompt for confirmation:

```
WARNING!
```

```
You are about to reinstall the application carousels.  
This will reset the Pro:Centric carousels to the  
factory default configuration and will delete any  
installed software updates or media files.  
It will not change configured network settings.
```

```
Are you sure you want to reinstall the carousels? [y/n]:
```

3. Either:

- Type **y** and press **Enter** to continue.
- Type **n** and press **Enter** to return to the Main Menu without reinstalling the Pro:Centric carousels.

If you opt to continue, progress messages will be displayed as the carousels are restored to the factory default configuration. When the installation is successfully completed, you will be prompted to reset the system:

```
Successfully reinstalled factory carousel applications  
Done
```

```
Please reset the system.
```

4. Reset the system (see "Reset the System" on page 38 for further information).

Exit the Current Session

At the `Command >` prompt, type **exit** and press **Enter** to end the current session.

Troubleshooting

PCS400R Setup

The following sections provide basic troubleshooting information for the PCS400R.

Equipment Setup Review

- Make sure all connectors and connections are tight and secure on all entertainment system components.
- Check the PCS400R LED. Under standard operating conditions, i.e., when the PCS400R is booted and operating normally, the PWR (Power) LED on the PCS400R front panel is continuously lit green. If there is a hardware fault, the PWR LED will turn and stay red.

Note: When power is first applied to the PCS400R, the PWR LED initially flashes red and then turns green (blinking during boot-up).

Network Setup

If the network is configured for DHCP but the PCS400R has not been assigned an IP address, i.e., the Ctrl IP field in the PCS400R System Information display is blank:

1. Check the Control Port connector on the rear panel of the PCS400R. Make sure the cable connection is tight and secure.
2. Observe the green LED on the Control Port. Once the PCS400R is connected to the network, the LED will be lit continuously.
3. Contact the network administrator to verify the network status and check that the DHCP server is working properly.

Troubleshooting (Cont.)

PCS400R Communication

If you are unable to establish remote communication with the PCS400R, refer to the following flow chart.

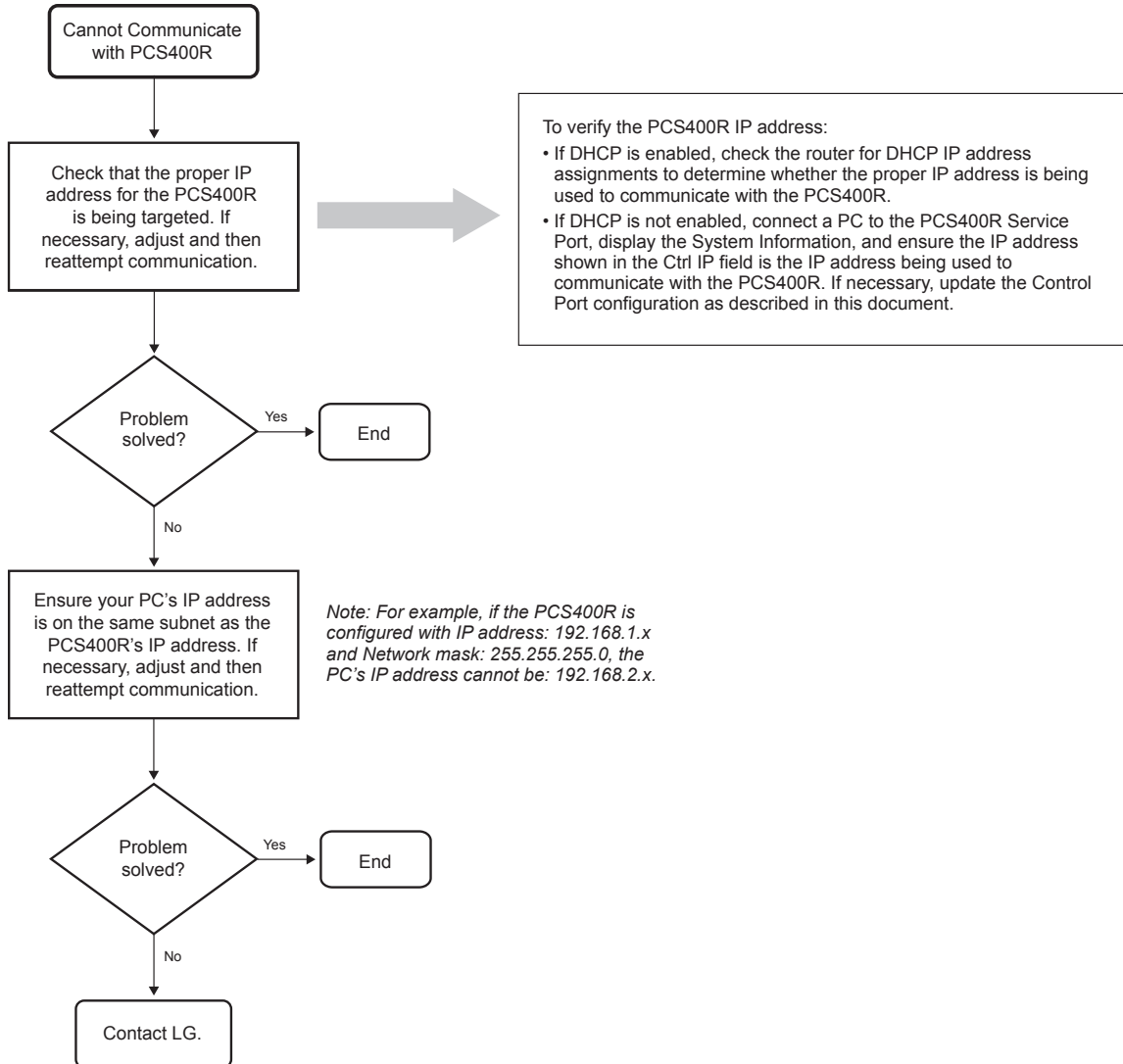

Specifications

Dimensions

Height:	1.692 inches (42.977 mm)
Width:	19.0 inches (482.6 mm) (for EIA standard 19-inch rack mount)
Depth:	8.5 inches (215.9 mm)
Weight:	5.65 pounds (2.56 kgrms) rack-only weight

Environmental Operating Conditions

Temperature (Tma):	0° to 40° Celsius 32° to 104° Fahrenheit
Humidity:	95% non-condensing

Environmental Storage Conditions

Temperature:	-20° to 70° Celsius -4° to 158° Fahrenheit
Humidity:	95% non-condensing

Electrical

RF Out Connectors (2)*:	75 Ohm, Type 'F'
Frequency:	VHF/UHF 54-865 MHz
RF Output Span:	Up to 8 Contiguous Channels (typically 48-64 MHz)
RF Output Frequency Range:	54 MHz to 865 MHz
Active Output Level at RF Out jacks:	-1 dBm (+47.75 dBmV) Typical
Test Output Level:	-47.75 dBm (+1 dBmV) Typical
Frequency Accuracy:	±5 ppm
Impedance at ASI Out jack:	75 Ohms
Level at ASI Out jack:	800 mv
DC Input:	+19V DC @ 2.2 Amps
Ethernet Connector (Control Port):	10/100/1000BaseT, RJ-45
Ethernet Connector (Feature Port):	100/1000BaseT Full Duplex, RJ-45

Modulation Specifications

Standard:	ITU-T J.83 Annex B (QAM-B)
Constellations:	64-QAM, 256-QAM
Symbol Rate:	64-QAM 5.056941 MBaud 256-QAM 5.360537 MBaud
Interleaving:	Fixed I = 128, J = 1

Standard:	EN 300 429 V1.2.1 (DVB-C)
Constellations:	64-QAM, 256-QAM
Symbol Rate:	64-QAM / 256-QAM 5.056 MBaud 64-QAM / 256-QAM 6.111 MBaud 64-QAM / 256-QAM 6.9 MBaud

Standard:	ABNT NBR 15601:2007 (ISDB-T)
Parameters:	64-QAM, 7/8 Convolutional Code, 1/32 Guard Interval Ratio, 2K FFT, 13 Segments
Sample Rate:	8.126984 Ms/s

* RF TAP connector reserved for service technician use only.

Note: Design and specifications subject to change without prior notice.

Document Revision History / Notes

Document Revision History

Date	Description
September 2017	Revision A: New document
July 2018	Revision B: Updates in conjunction with PCD 2.5
September 2018	Revision C: Trademark update
December 2018	Revision D: Updates in conjunction with PCD 3.0

Product documentation is available online at: www.lg.com/us/business.

Notes

Open Source Software Notice

Product Type	Pro:Centric Server
Model Number/Range	PCS400R

This product from LG Electronics, Inc. (“LGE”) contains the open source software detailed below. Please refer to the indicated open source licences for the terms and conditions of their use.



Warning: The PCS400R is intended for Commercial use only. It is not a Consumer product and should not be installed in residential dwellings.

Open Source	License	Copyright
abrt 2.1.11	GPL-2.0	Copyright (c) 2014 ABRT team
abrt-addon-ccpp 2.1.11	GPL-2.0	
abrt-addon-kerneloops 2.1.11	GPL-2.0	
abrt-addon-pstoreoops 2.1.11	GPL-2.0	
abrt-addon-python 2.1.11	GPL-2.0	
abrt-addon-vmcore 2.1.11	GPL-2.0	
abrt-addon-xorg 2.1.11	GPL-2.0	
abrt-cli 2.1.11	GPL-2.0	
abrt-console-notification 2.1.11	GPL-2.0	
abrt-dbus 2.1.11	GPL-2.0	
abrt-libs 2.1.11	GPL-2.0	
abrt-python 2.1.11	GPL-2.0	
abrt-retrace-client 2.1.11	GPL-2.0	
abrt-tui 2.1.11	GPL-2.0	
acl 2.2.51	GPL-2.0, LGPL-2.1	Copyright (c) 2015 Free Software Foundation, Inc.
alsa-firmware 1.0.28	GPL-2.0	
alsa-lib 1.0.28	LGPL-2.1	Copyright (c) 2000 by Abramo Bagnara <abramo@alsa-project.org>, Jaroslav Kysela <perex@perex.cz>
alsa-tools-firmware 1.0.28	GPL-2.0	
at 3.1.13	GPL-2.0	Copyright (c) 1993, 1994, 1995, 1996, 1997 Thomas Koenig Copyright (c) 2002, 2005 Ryan Murray Atrun & Atq modifications Copyright (c) 1993 David Parsons
ATK 2.14.0	LGPL-2.1	
attr 2.4.46	GPL-2.0	Copyright (c) 2006 Andreas Gruenbacher <agruen@suse.de>, SuSE Linux AG
attr-libattr 2.4.46	LGPL-2.1	Copyright (c) Andreas Grünbacher <agruen@kernel.org>, October 2015

Open Source Software Notice (Cont.)

audit 2.4.1	GPL-2.0, LGPL-2.1	Copyright (c) 2004-2015 Red Hat Inc., Durham, North Carolina
augeas 1.4.0	LGPL-2.1	Copyright (c) 2007-2016 David Lutterkort
authconfig 6.2.8	GPL-2.0	Copyright (c) 1999-2014 Red Hat, Inc.
autogen 5.18	LGPL-3.0	
avahi 0.6.31	LGPL-2.1	
bash 4.2.46	GPL-3.0	Copyright (c) 2007, 2009, 2011, 2014 Free Software Foundation, Inc.
bash-completion 2.1	GPL-2.0	
bc 1.06.95	GPL-2.0	Copyright (c) 1998, 2001, 2003, 2014 Free Software Foundation, Inc.
binutils 2.23.52.0.1	GPL-3.0	Copyright (c) 1991, 1992, 1993, 1994, 1995, 1996, 1997, 1998, 1999, 2000, 2001, 2002, 2003, 2004, 2005, 2006, 2007, 2008, 2009 Free Software Foundation, Inc.
biosdevname 0.6.2	GPL-2.0	Copyright (c) 2006 Dell, Inc. by Matt Domsch <Matt_Domsch@dell.com>
blktrace 1.0.5	GPL-2.0	Copyright (c) 2005 Jens Axboe <axboe@suse.de> Copyright (c) 2006 Jens Axboe <axboe@kernel.dk>
bridge-utils 1.5	GPL-2.0	Copyright (c) 2000 Lennert Buytenhek
btrfs-progs 3.19.1	GPL-2.0	Copyright (c) 2007 Oracle
cairo 1.14.2	LGPL-2.1	Copyright (c) 2010 Chris Wilson <chris@chris-wilson.co.uk>
CgosDrv	GPL-2.0	
checkpolicy 2.5	GPL-2.0	Copyright (c) 2017 Mellanox Technologies Inc. Copyright (c) 2004-2005 Trusted Computer Solutions, Inc. Copyright (c) 2003 - 2005 Tresys Technology, LLC Copyright (c) 2003 Red Hat, Inc., James Morris <jmorris@redhat.com>
chkconfig 1.3.61	GPL-2.0	
chkconfig-ntsysv 1.3.61	GPL-2.0	
chrony 2.1.1	GPL-2.0	Copyright (c) 1997-2003 Richard P. Curnow Copyright (c) 2009 John G. Hasler Copyright (c) 2012-2015 Miroslav Lichvar
container-selinux 2.21	GPL-2.0	
coreutils 8.22	GPL-3.0	
cpio 2.11	GPL-3.0	Copyright (c) 2001, 2004, 2005, 2006 Free Software Foundation, Inc.
cracklib 2.9.0	LGPL-2.1	Copyright (c) 1993 Alec Muffett <alecm@crypto.dircon.co.uk> Original CrackLib author for releases up to v2.7 Copyright (c) Nathan Neulinger <nneul@neulinger.org> version 3.0 modifications and new release
crontabs 1.11	GPL-2.0	

Open Source Software Notice (Cont.)

cryptsetup 1.6.7	GPL-2.0	Copyright (c) 2004 Jana Saout <jana@saout.de> Copyright (c) 2004-2007 Clemens Fruhwirth <clemens@endorphin.org> Copyright (c) 2009-2012 Red Hat, Inc. Copyright (c) 2009-2014 Milan Broz
dbus 1.6.12	GPL-2.0	
dbus-glib 0.1	GPL-2.0	
desktop-file-utils 0.22	GPL-2.0	Copyright (c) 2007-2009 Vincent Untz <vuntz@gnome.org>
device-mapper 1.02.107	GPL-2.0, LGPL-2.1	
device-mapper-persistent-data 0.5.5	GPL-3.0	
diffutils 3.3	GPL-3.0	Copyright (c) 1992, 1993, 1994, 1995, 1996, 1998, 2001, 2002 Free Software Foundation, Inc.
dmidecode 2.12	GPL-2.0	
dmraid 1.0.0.rc16	GPL-2.0	
dnsmasq 2.66	GPL-2.0	
dosfstools 3.0.20	GPL-3.0	Copyright (c) 2004-2015 Canonical Ltd
dracut 33	GPL-2.0	
dyninst 8.2.0	LGPL-2.1	
e2fsprogs 1.42.9	GPL-2.0	Copyright 1995, 1996, 1997, 1998, 1999, 2000, 2001, 2002, 2003, 2004, 2005, 2006, 2007, 2008, 2009, 2010 by Theodore Ts'o
eatables 2.0.10-4	GPL-2.0	Copyright (c) 1999 Paul 'Rusty' Russell & Michael J. Neuling Copyright (c) 2001-2002 Bart De Schuymer
ed 1.9	GPL-3.0	
elfutils 0.163	GPL-2.0, GPL-3.0	
emacs 24.3	GPL-3.0	Copyright (c) 2015 Free Software Foundation, Inc.
ethtool 3.15	GPL-2.0	Copyright (c) 1998 David S. Miller (davem@dm.cobaltmicro.com) Portions Copyright 2001 Sun Microsystems Kernel 2.4 update Copyright 2001 Jeff Garzik <jgarzik@mandrakesoft.com> Wake-on-LAN, natsemi, misc support by Tim Hockin <thockin@sun.com> Portions Copyright (c) 2002 Intel Portions Copyright (c) 2008 Sun Microsystems do_test support by Eli Kupermann <eli.kupermann@intel.com> ETHTOOL_PHYS_ID support by Chris Leech <christopher.leech@intel.com> e1000 support by Scott Feldman <scott.feldman@intel.com> e100 support by Wen Tao <wen-hwa.tao@intel.com> ixgb support by Nicholas Nunley <Nicholas.d.nunley@intel.com> amd8111e support by Reeja John <reeja.john@amd.com> long arguments by Andi Kleen

Open Source Software Notice (Cont.)

		SMSC LAN911x support by Steve Glendinning <steve.glendinning@smc.com> Rx Network Flow Control configuration support <santwona.behera@sun.com> Various features by Ben Hutchings <bhutchings@solarflare.com>; Copyright (c) 2009, 2010 Solarflare Communications MDI-X set support by Jesse Brandeburg <jesse.brandeburg@intel.com> Copyright (c) 2012 Intel Corporation
findutils 4.5.11	GPL-3.0	
firewalld 0.3.9	GPL-2.0	
flac 1.3.0	GPL-2.0	Copyright (c) 2002-2009 Josh Coalson Copyright (c) 2011-2013 Xiph.Org Foundation Copyright (c) 2001 Edmund Grimley Evans <edmund@rano.org> Copyright (c) 2003 Philip Jägenstedt Copyright (c) 2001 David Robinson and Glen Sawyer Copyright (c) 1998-2000 Peter Alm, Mikael Alm, Olle Hallnas, Thomas Nilsson and 4Front Technologies
fprintd 0.5.0	GPL-2.0	
fxload 2002_04_11	GPL-2.0	
gawk 4.0.2	GPL-2.0	Copyright (c) 2008 Free Software Foundation, Inc.
gconf 3.2.6	LGPL-2.1	Copyright (c) 1999, 2000 Red Hat, Inc.
gdb 7.6.1	GPL-3.0	Copyright (c) 1996, 1998, 1999, 2000, 2002, 2003, 2005, 2006, 2007, 2008, 2009 Free Software Foundation, Inc.
gdbm 1.1	GPL-2.0	Copyright (c) 1990, 1991, 1993 Free Software Foundation, Inc.
gdk-pixbuf 2.31.6	LGPL-2.1	Copyright (c) 2005-2014 The GNOME Project Copyright (c) 1999 The Free Software Foundation Copyright (c) 2000 Red Hat, Inc. Copyright (c) 2008 Dominic Lachowicz Copyright (c) 2008 Alberto Ruiz Copyright (c) 1999 Mark Crichton Copyright (c) 1999 2001 Tim Janik
gettext 0.18.2.1	GPL-3.0, LGPL-2.1	Copyright (c) 1998, 2010, 2013 Free Software Foundation, Inc.
GLib 2.42.2	LGPL-2.1	
glib-networking 2.42.0	LGPL-2.1	Copyright (c) 2011 Collabora, Ltd Copyright (c) 2011-2013 Red Hat, Inc.
glibc 2.17	LGPL-2.1	
gmp 6.0.0	LGPL-3.0	
GNU nano - an enhanced clone of the Pico text editor 2.3.1	GPL-3.0	
GnuPG 2.0.22	GPL-3.0	
GnuTLS 3.3.8	LGPL-2.1	Copyright (c) 2011-2012 Free Software Foundation, Inc.
gobject-introspection 1.42.0	LGPL-2.1	Copyright (c) 2005-2015 The GNOME Project

Open Source Software Notice (Cont.)

GPGME 1.3.2	LGPL-2.1	Copyright (c) 2000 Werner Koch (dd9jn) Copyright (c) 2001, 2002, 2003, 2004, 2005, 2007, 2012, 2014, 2015 g10 Code GmbH
gpm 1.20.7	GPL-2.0	
graphite2 1.3.6	LGPL-2.1	
grep 2.2	GPL-3.0	Copyright (c) 1996-2014 Free Software Foundation, Inc.
grub2 2.02	GPL-3.0	
grubby 8.28	GPL-2.0	
gsettings-desktop-schemas 3.14.2	LGPL-2.1	
GTK+ 2.24.28	LGPL-2.1	Copyright (c) 2003-2011 by the gtk2-perl team
gzip 1.5	GPL-3.0	Copyright (c) 1999, 2001-2002, 2006-2007, 2009-2016 Free Software Foundation, Inc. Copyright (c) 1992-1993 Jean-loup Gailly
hardlink 1	GPL-2.0	
hicolor-icon-theme 0.12	GPL-2.0	
hostname 3.13	GPL-2.0	Copyright (c) 1994-1997 Peter Tobias <tobias@et-inf.fho-emden.de> 2009- Michael Meskes <meskes@debian.org>
hunspell 1.3.2	LGPL-2.1	
hunspell 0.20121024	LGPL-2.1	
hwdata 0.252	GPL-2.0	
initscripts 9.49.30	GPL-2.0	
iproute2 3.10.0	GPL-2.0	Copyright (c) 2009 Alexey Kuznetsov
iprutils 2.4.8	CPL-1.0	Copyright (c) 2000, 2004 International Business Machines Corporation and others
iptables 1.4.21	GPL-2.0	
iputils 2	GPL-2.0	
irqbalance 1.0.7	GPL-2.0	
java-1.8.0-openjdk 1.8.0.91	GPL-2.0-with-classpath-exception	
java-1.8.0-openjdk-debug 1.8.0.91	GPL-2.0-with-classpath-exception	
java-1.8.0-openjdk-devel 1.8.0.91	GPL-2.0-with-classpath-exception	
java-1.8.0-openjdk-devel-debug 1.8.0.91	GPL-2.0-with-classpath-exception	

Open Source Software Notice (Cont.)

java-1.8.0-openjdk-headless 1.8.0.91	GPL-2.0-with-classpath-exception	
java-1.8.0-openjdk-headless-debug 1.8.0.91	GPL-2.0-with-classpath-exception	
jbigkit-libs 2	GPL-2.0	
kbd 1.15.5	GPL-2.0	
kexec-tools 2.0.7	GPL-2.0	
keyutils 1.5.8	LGPL-2.1	
kmod 20	GPL-2.0, LGPL-2.1	
kpatch 0.1.10	GPL-2.0	
langtable 0.0.31	GPL-3.0	
ledmon 0.79	GPL-2.0	
libaio 0.3.109	LGPL-2.1	Copyright (c) 2002 Red Hat, Inc. Copyright (c) 2001-2005 Russell King
libassuan 2.1.0	GPL-3.0	Copyright (c) 2010 Free Software Foundation, Inc.
libasyncns 0.8	LGPL-2.1	
libblkid 2.23.2	LGPL-2.1	Copyright (c) 2009-2013 Karel Zak <kzak@redhat.com>
libcap-ng 0.7.5	LGPL-2.1	
libconfig 1.4.9	LGPL-2.1	
libcroco 0.6.8	LGPL-2.1	
libdaemon 0.14	LGPL-2.1	
libdwarf 2	LGPL-2.1	
libestr 0.1.9	LGPL-2.1	
libfprint 0.5.0	LGPL-2.1	
libgcrypt 1.5.3	LGPL-2.1	Copyright (c) 1998, 1999, 2000, 2001, 2002, 2003, 2004, 2006, 2007, 2008, 2009, 2010, 2011, 2012 Free Software Foundation, Inc. Copyright (c) 2012, 2013 g10 Code GmbH
libgpg-error 1.12	LGPL-2.1	Copyright (c) 2003, 2004 g10 Code GmbH Copyright (c) 1995, 1996, 1997, 1999, 2005, 2007, 2008, 2010 Free Software Foundation, Inc.
libidn 1.28	GPL-3.0	
libmnl 1.0.3	LGPL-2.1	Copyright (c) 1999-2014 Harald Welte, Pablo Neira Ayuso
libmodman 2.0.1	LGPL-2.1	
libmount 2.23.2	LGPL-2.1	
libndp 1.2	LGPL-2.1	Copyright (c) 2013-2015 Jiri Pirko <jiri@resnulli.us>
libnetfilter-contrack 1.0.4	GPL-2.0	Copyright (c) 1999-2014 Harald Welte, Pablo Neira Ayuso

Open Source Software Notice (Cont.)

libnfnetlink 1.0.1	GPL-2.0	Copyright (c) 2001-2005 Netfilter Core Team <coreteam@netfilter.org>
libnl 3.2.21	LGPL-2.1	Copyright (c) 2003-2013 Thomas Graf <tgraf@suug.ch> Copyright (c) 2007 Secure Computing Corporation Copyright (c) 2007 Philip Craig <philipc@snapgear.com> Copyright (c) 1992-2013 Free Software Foundation, Inc. Copyright (c) 2013 Sassano Systems LLC <joe@sassanosystems.com> Copyright (c) 2013 Cong Wang <xiyou.wangcong@gmail.com> Copyright (c) 2014 Susant Sahani <susant@redhat.com> Copyright (c) 2012 Rich Fought <rich.fought@watchguard.com> Copyright (c) 2007, 2008 Patrick McHardy <kaber@trash.net>
libnl 1.1.4	LGPL-2.1	
libpipeline 1.2.3	GPL-3.0	
libproxy 0.4.11	LGPL-2.1	
libpwquality 1.2.3	GPL-2.0	
libreport 2.1.11	GPL-2.0	
librsvg2 2.39.0	LGPL-2.1	Copyright (c) 2000 Eazel, Inc. Copyright (c) 2002 Dom Lachowicz <cinamod@hotmail.com> Copyright (c) 1998-2000 Red Hat, Inc. Copyright (c) 2004 Caleb Moore Copyright (c) 2011 Christian Persch
libseccomp 2.3.1	LGPL-2.1	Copyright (c) 2012, 2018 Red Hat <pmoore@redhat.com>
libsemanage 2.5	LGPL-2.1	Copyright (c) 2005 Red Hat, Inc.
libsemanage 2.1.10	LGPL-2.1	
libsepol 2.1.9	LGPL-2.1	
libsndfile 1.0.25	LGPL-2.1	Copyright (c) 1999-2011 Erik de Castro Lopo
libsoup 2.48.1	LGPL-2.1	Copyright (c) 2007 Red Hat, Inc. Copyright (c) 2000-2003 Ximian, Inc. Copyright (c) 2007 Novell, Inc. Copyright (c) 2009, 2010 Igalia S.L.
libstoragemgmt 1.2.3	LGPL-2.1	Copyright (c) Tony Asleson <tasleson@redhat.com>
libsysfs 2.1.0	LGPL-2.1	
libtasn1 3.8	LGPL-2.1	Copyright (c) 2002-2014 Free Software Foundation, Inc.
libteam 1.17	LGPL-2.1	Copyright (c) 2011-2015 Jiri Pirko jiri@resnulli.us
libthai 0.1.14	LGPL-2.1	
libtool 2.4.2	LGPL-2.1	
libunistring 0.9.3	LGPL-3.0	
libusb 0.1.4	LGPL-2.1	Copyright (c) 2008 Daniel Drake <dsd@gentoo.org> Copyright (c) 2000-2003 Johannes Erdfelt <johannes@erdfelt.com>
libusbx 1.0.15	LGPL-2.1	
libuser 0.60	LGPL-2.1	Copyright (c) 2000-2002, 2007, 2008 Red Hat, Inc.

Open Source Software Notice (Cont.)

libutempter 1.1.6	LGPL-2.1	
libwmf 0.2.8.4	GPL-2.0	
Linux Kernel 3.10.0	GPL-2.0	
linux-firmware	GPL-2.0	
lksctp-tools 1.0.13	GPL-2.0	
Imsensors 3.3.4	LGPL-2.1	Copyright (c) Frodo Looijaard Copyright (c) Merlin Hughes Copyright (c) Bob Schlaermann Copyright (c) Mark M. Hoffman Copyright (c) Jean Delvare
logrotate 3.8.6	GPL-2.0	
lsscsi 0.27	GPL-2.0	Copyright (c) 2002-2004 D. Gilbert
lvm2 2.02.130	GPL-2.0	Copyright (c) 2008, 2009 Red Hat, Inc.
lvm2 2.02.171	LGPL-2.1	
LZMA Utils 5.1.2	LGPL-2.1	
lzo 2.06	GPL-2.0	
make 3.82	GPL-3.0	
man-db 2.6.3	GPL-2.0	
mariadb 5.5.44	GPL-2.0	Copyright (c) 2017 MariaDB
mariadb 10.1.13	GPL-2.0	Copyright (c) 2017 MariaDB
mariadb 10.0.24	GPL-2.0	Copyright (c) 2017 MariaDB
mariadb-galera 25.3.15	GPL-2.0	
mcstrans 0.3.4	GPL-2.0	Copyright (c) 2006 Trusted Computer Solutions, Inc.
mdadm 3.3.2	GPL-2.0	
microcode_ctl 2.1	GPL-2.0	
mjet.ko 3.2	GPL-2.0	Copyright (c) 2012, 2013 Zenith/LG Electronics
mlocate 0.26	GPL-2.0	
mtr 0.85	GPL-2.0	
multipath-tools 0.4.9	GPL-2.0	
net-tools 1.6	GPL-2.0	Copyright (c) 1997, 1999, 2000 Andi Kleen Copyright (c) 1994 John Paul Morrison (VE7JPM)
nettle 2.7.1	LGPL-2.1	
NetworkManager 1.0.6	GPL-2.0	
newt 0.52.15	LGPL-2.1	
newt-python 0.52.15	LGPL-2.1	
nspr 4.11	MPL-2.0	
nss 3.21.0	MPL-2.0	
nss 3.19.1	MPL-2.0	

Open Source Software Notice (Cont.)

nss 3.16.2.3	MPL-2.0	
numactl-libs 2.0.9	LGPL-2.1	
OpenVPN 2.3.10	GPL-2.0	Copyright (c) 2013 by the Open-Source OpenVPN development community
os-prober 1.58	GPL-2.0	
pango 1.36.8	LGPL-2.1	Copyright (c) 1999 Red Hat Software
parted 3.1	GPL-3.0	
pciutils 3.2.1	GPL-2.0	Copyright (c) 1997-2013 Martin Mares <mj@ucw.cz>
php56u-pear 1.10.1	LGPL-3.0	
pinentry 0.8.1	GPL-2.0	Copyright (c) 2002 g10 Code GmbH Copyright (c) 2001 Free Software Foundation, Inc. Copyright (c) 1992-2002 Trolltech AS Copyright (c) 2003 g10 Code GmbH Copyright (c) 2008 Klarälvdalens Datakonsult AB (KDAB) Copyright (c) 2008 Nokia Corporation and/or its subsidiary(-ies) Copyright (c) 1999 Robert Bihlmeyer <robbe@orcus.priv.at> Copyright (c) 1995-1997 Peter Mattis, Spencer Kimball and Josh MacDonald Copyright (c) 1992-2008 Trolltech ASA
pinfo 0.6.10	GPL-2.0	
pkcs11-helper 1.11	GPL-2.0	
pkgconfig 0.27.1	GPL-2.0	
plymouth 0.8.9	GPL-2.0	
plymouth-core-libs 0.8.9	GPL-2.0	
plymouth-scripts 0.8.9	GPL-2.0	
pm-utils 1.4.1	GPL-2.0	
pm2 2.9.3	AGPL-3.0	Copyright (c) 2013 the PM2 project authors
policycoreutils 2.2.5	GPL-2.0	
polkit 0.112	LGPL-2.1	
polkit-pkla-compat 0.1	LGPL-2.1	
postfix 2.10.1	GPL-2.0	
ppp 2.4.5	GPL-2.0	Copyright (c) 2000 by Roaring Penguin Software Inc. Copyright (c) 2006, 2007, 2008 Katalix Systems Ltd.
procps-ng 3.3.10	GPL-2.0	
psacct 6.6.1	GPL-3.0	
psmisc 22.20	GPL-2.0	
pth 2.0.7	LGPL-2.1	
pulseaudio 6	LGPL-2.1	
pygobject2 2.28.6	LGPL-2.1	
pygobject3-base 3.14.0	LGPL-2.1	

Open Source Software Notice (Cont.)

pygpgme 0.3	LGPL-2.1	
pyliblzma 0.5.3	LGPL-3.0	
python-augeas 0.5.0	LGPL-2.1	
python-chardet 2.2.1	LGPL-2.1	
python-dmidecode 3.10.13	GPL-2.0	
python-kitchen 1.1.1	LGPL-2.1	
python-perf 3.10.0	GPL-2.0	
python-pycurl 7.19.0	LGPL-2.1	
python-pyudev 0.15	LGPL-2.1	
python-slip 0.4.0	GPL-2.0	
python-systemd 219	LGPL-2.1	
python-urlgrabber 3.1	LGPL-2.1	
pyxattr 0.5.1	LGPL-2.1	
qrencode 3.4.1	LGPL-2.1	
rdate 1.4	GPL-2.0	
rdma 7.2_4.1_rc6	GPL-2.0	
readline 6.2	GPL-3.0	
rng-tools 5	GPL-2.0	
rpm 4.11.3	GPL-2.0	
rpm-build-libs 4.11.3	GPL-2.0	
rpm-libs 4.11.3	GPL-2.0	
rpm-python 4.11.3	GPL-2.0	
rsync 3.1.2	GPL-3.0	Copyright (c) 1996 Andrew Tridgell Copyright (c) 1996 Paul Mackerras Copyright (c) 2003-2015 Wayne Davison
rsync 3.0.9	GPL-3.0	
rsyslog 7.4.7	GPL-3.0	
satyr 0.13	GPL-2.0	
scl-utils 2.0	GPL-2.0	
sed 4.2.2	GPL-3.0	
selinux-policy 3.13.1	GPL-2.0	
selinux-policy-targeted 3.13.1	GPL-2.0	
setools3-libseaudit 3.3.8	LGPL-2.1	Copyright (C) 2004-2007 Tresys Technology, LLC
setserial 2.17	GPL-2.0	Copyright (c) 1994 by Theodore Ts'o <tytso@mit.edu>
setuptools 1.19.11	GPL-2.0	
sgpio 1.2.0.10	GPL-2.0	

Open Source Software Notice (Cont.)

shadow-utils 4.1.5.1	GPL-2.0	
shared-mime-info 1.1	GPL-2.0	
slang 2.2.4	GPL-2.0	
smartmontools 6.2	GPL-2.0	
sos 3.2	GPL-2.0	
SpiderMonkey 17.0.0	MPL-2.0	
sssd 1.13.0	GPL-3.0	
SwingX 1.6	LGPL-2.1	Copyright (c) 2005-2006 Sun Microsystems, Inc
sysstat 10.1.5	GPL-2.0	
systemd 219	GPL-2.0 LGPL-2.1	
systemd	LGPL-2.1	
systemtap 2.8	GPL-2.0	Copyright (c) 2011 Red Hat, Inc. Copyright (c) 2006 IBM Corporation
sysvinit-tools 2.88	GPL-2.0	
t1lib 5.1.2	GPL-2.0	
tar 1.26	GPL-3.0	
textinfo 5.1	GPL-3.0	
time 1.7	GPL-2.0	
traceroute 2.0.19	GPL-2.0	
ttmkfdir 3.0.9	LGPL-2.1	
tuned 2.5.1	GPL-2.0	
urw-fonts 2.4	GPL-2.0	
usbutils 007	GPL-2.0	
usb_modeswitch 2	GPL-2.0	
usb_modeswitch 1.2.7	GPL-2.0	
usermode 1.111	GPL-2.0	
Util-Linux 2.23.2	GPL-2.0	
virt-what 1.13	GPL-2.0	
wget 1.14	GPL-3.0	
which 2.2	GPL-3.0	Copyright (c) 2017 Free Software Foundation, Inc.
xfsdump 3.1.4	GPL-2.0	
xfsprogs 3.2.2	GPL-2.0	
xgbeth 1.00a	GPL-2.0	Copyright (c) 2009-2011 Xilinx, Inc.
XZ Utils 5.1.2	LGPL-2.1	
yum 3.4.3	GPL-2.0	

Open Source Software Notice (Cont.)

yum-langpacks 0.4.2	GPL-2.0	
yum-metadata-parser 1.1.4	GPL-2.0	
yum-utils 1.1.31	GPL-2.0	

The source code and other important information for the above may be obtained free of charge from LGE at <http://opensource.lge.com>. LGE will also provide open source code to you on CD-ROM for a charge covering the cost of performing such distribution (such as the cost of media, shipping, and handling) upon e-mail request to opensource@lge.com. This offer is valid for a period of three years after our last shipment of this product. This offer is valid to anyone in receipt of this information.

Please be informed that LG Electronics, Inc. products may contain open source software listed in the table below.

Open Source	License	Copyright
abbrev-js 1.1.1	ISC	Copyright (c) Isaac Z. Schlueter and contributors
abbrev-js 1.0.9	ISC	Copyright (c) Isaac Z. Schlueter and contributors
accepts 1.3.4	MIT	Copyright (c) 2014 Jonathan Ong < me@jongleberry.com > Copyright (c) 2015 Douglas Christopher Wilson < doug@somethingdoug.com >
acorn 5.4.1	MIT	Copyright (c) 2012-2018 by various contributors
acorn 4.0.13	MIT	Copyright (c) 2012-2014 by various contributors
acorn 3.3.0	MIT	Copyright (c) 2012-2014 by various contributors
acorn-globals 3.1.0	MIT	Copyright (c) 2014 Forbes Lindesay
acorn-jsx 3.0.1	MIT	Copyright (c) 2012-2014 by Ingvar Stepanyan
address 1.0.3	MIT	Copyright (c) 2013-2014 fengmk2 < fengmk2@gmail.com > Copyright (c) 2015-2016 node-modules
adminer 4.7.0	Apache-2.0	Copyright (c) 2007 Jakub Vrana
ajv 6.5.4	MIT	Copyright (c) 2015-2017 Evgeny Poberezkin
ajv 5.5.2	MIT	Copyright (c) 2015 Evgeny Poberezkin
ajv 4.11.8	MIT	Copyright (c) 2015 Evgeny Poberezkin
ajv-keywords 3.2.0	MIT	
ajv-keywords 1.5.1	MIT	Copyright (c) 2016 Evgeny Poberezkin
align-text 0.1.4	MIT	Copyright (c) 2015 Jon Schlinkert
amdefine 1.0.1	BSD-3-Clause	Copyright (c) 2011-2016 The Dojo Foundation
ansi-align 2.0.0	ISC	Copyright (c) 2016 Contributors
ansi-escapes 1.4.0	MIT	Copyright (c) Sindre Sorhus < sindresorhus@gmail.com > (sindresorhus.com)
ansi-regex 3.0.0	MIT	Copyright (c) Sindre Sorhus < sindresorhus@gmail.com > (sindresorhus.com)
ansi-regex 2.1.1	MIT	Copyright (c) Sindre Sorhus < sindresorhus@gmail.com > (sindresorhus.com)

Open Source Software Notice (Cont.)

ansi-styles 3.2.0	MIT	Copyright (c) Sindre Sorhus <sindresorhus@gmail.com> (sindresorhus.com)
ansi-styles 2.2.1	MIT	Copyright (c) Sindre Sorhus <sindresorhus@gmail.com> (sindresorhus.com)
ansicolors 0.3.2	MIT	Copyright (c) 2013 Thorsten Lorenz
ansicolors 0.2.1	MIT	Copyright (c) 2013 Thorsten Lorenz
any-promise 1.3.0	MIT	Copyright (c) 2014-2016 Kevin Beaty
anymatch 1.3.2	ISC	Copyright (c) 2014 Elan Shanker
Apache Ant 1.6.5	Apache-2.0	
Apache Commons EL	Apache-1.1	
Apache Commons FileUpload	Apache-2.0	Copyright (c) 2002-2014 The Apache Software Foundation. All Rights Reserved.
Apache Commons IO	Apache-2.0	
Apache Commons Modeler	Apache-2.0	Copyright (c) 2001-2007 The Apache Software Foundation
Apache Commons Net	Apache-2.0	Copyright (c) 2001-2013 The Apache Software Foundation
Apache Derby	Apache-2.0	
Apache HttpComponents	Apache-2.0	
Apache James	Apache-2.0	Copyright (c) 2006-2017 The Apache Software Foundation
Apache ORO 2.0.8	Apache-2.0	Copyright (c) 2000-2002 The Apache Software Foundation
Apache Tomcat 6.0.0	Apache-2.0	
apparatus 0.0.9	MIT	Copyright (c) 2011 Chris Umbel
apr 1.5.4	Apache-2.0	Copyright (c) 2008-2016 The Apache Software Foundation
apr 1.5.2	Apache-2.0	
apr 1.4.8	Apache-2.0	Copyright (c) 2008-2016 The Apache Software Foundation
apr-util 1.5.2	Apache-2.0	
aproba 1.2.0	ISC	Copyright (c) 2015 Rebecca Turner <me@re-becca.org>
are-we-there-yet 1.1.4	ISC	Copyright (c) 2015 Rebecca Turner
arr-diff 4.0.0	MIT	Copyright (c) 2014-2017 Jon Schlinkert
arr-diff 2.0.0	MIT	Copyright (c) 2014-2015 Jon Schlinkert
arr-flatten 1.1.0	MIT	Copyright (c) 2014-2015 Jon Schlinkert
array-flatten 1.1.1	MIT	Copyright (c) 2014 Blake Embrey (hello@blakeembrey.com)
array-union 1.0.2	MIT	Copyright (c) Sindre Sorhus <sindresorhus@gmail.com> (sindresorhus.com)
array-uniq 1.0.3	MIT	Copyright (c) Sindre Sorhus <sindresorhus@gmail.com> (sindresorhus.com)
array-unique 0.3.2	MIT	Copyright (c) 2014-2016 Jon Schlinkert
array-unique 0.2.1	MIT	Copyright (c) 2015 Jon Schlinkert

Open Source Software Notice (Cont.)

arrify 1.0.1	MIT	Copyright (c) Sindre Sorhus <sindresorhus@gmail.com> (sindresorhus.com)
ASAP 2.0.6	MIT	Copyright (c) 2009–2014 Contributors
assertion-error 1.1.0	MIT	Copyright (c) 2013 Jake Luer <jake@qualiancy.com> (http://qualiancy.com)<jake@qualiancy.com>
assign-symbols 1.0.0	MIT	Copyright (c) 2015 Jon Schlinkert
async 2.6.0	MIT	Copyright (c) 2010-2017 Caolan McMahon
async 1.5.2	MIT	Copyright (c) 2010-2014 Caolan McMahon
async 1.0.0	MIT	Copyright (c) 2010-2014 Caolan McMahon
async 0.9.2	MIT	
async 0.2.10	MIT	Copyright (c) 2010 Caolan McMahon
async-each 1.0.1	MIT	Copyright (c) 2013 Paul Miller [paulmillr.com] (http://paulmillr.com)
async-listener 0.6.8	BSD-2-Clause	Copyright (c) 2013-2017 Forrest L Norvel
asynckit 0.4.0	MIT	Copyright (c) 2016 Alex Indigo
atob 2.0.3	MIT	Copyright (c) 2012-2015 AJ ONeal
aws-sign2 0.7.0	Apache-2.0	Copyright (c) Mikeal Rogers <mikeal.rogers@gmail.com> (http://www.futurealoof.com)
aws-sign2 0.6.0	Apache-2.0	Copyright (c) Mikeal Rogers <mikeal.rogers@gmail.com> (http://www.futurealoof.com)
aws4 1.6.0	MIT	Copyright (c) 2013 Michael Hart (michael.hart.au@gmail.com)
axon 3.1.0	MIT	Copyright (c) 2012-2013 TJ Holowaychuk <tj@vision-media.ca>
babel 7.1.2	MIT	Copyright (c) 2014-2018 Sebastian McKenzie and other contributors
babel 7.0.0	MIT	Copyright (c) 2014-2018 Sebastian McKenzie and other contributors
babel 6.26.3	MIT	
babel 6.26.1	MIT	Copyright (c) 2014-2017 Sebastian McKenzie <sebmck@gmail.com>
babel 6.26.0	MIT	Copyright (c) 2014-2017 Sebastian McKenzie <sebmck@gmail.com>
babel 6.24.1	MIT	Copyright (c) 2014-2017 Sebastian McKenzie <sebmck@gmail.com>
babel 6.23.0	MIT	Copyright (c) 2014-2017 Sebastian McKenzie <sebmck@gmail.com>
babel 6.22.0	MIT	Copyright (c) 2014-2018 Sebastian McKenzie and other contributors
babel 6.13.0	MIT	Copyright (c) 2014-2018 Sebastian McKenzie and other contributors
babel-babylon 6.18.0	MIT	Copyright (c) 2012-2014 by various contributors (see AUTHORS)

Open Source Software Notice (Cont.)

babel-loader 6.4.1	MIT	Copyright (c) 2016 Luís Couto <couto@15minuteslate.net>
babel-plugin-lodash 3.3.4	MIT	Copyright (c) JS Foundation and other contributors <https://js.foundation=""/></https:>
balanced-match 1.0.0	MIT	Copyright (c) 2013 Julian Gruber <julian@juliangruber.com>
base-base 0.11.2	MIT	CCopyright (c) 2015-2016 Jon Schlinkert
basic-auth 2.0.0	MIT	Copyright (c) 2013 TJ Holowaychuk Copyright (c) 2014 Jonathan Ong <me@jongleberry.com> Copyright (c) 2015 Douglas Christopher Wilson <doug@somethingdoug.com>
bcrypt-pbkdf 1.0.1	BSD-3-Clause	
beatgammit-base64-js 1.2.1	MIT	
big.js 3.2.0	MIT	Copyright (c) 2012 Michael Mclaughlin
bignumber.js 4.0.4	MIT	Copyright (c) 2012, 2013, 2014, 2015, 2016, 2017 Michael Mclaughlin
binary-extensions 1.11.0	MIT	
BIND 9.9.4	ISC	Copyright (c) 2017 Internet Systems Consortium
blessed 0.1.81	MIT	Copyright (c) 2013-2015 Christopher Jeffrey and contributors
block-stream 0.0.9	ISC	Copyright (c) Isaac Z. Schlueter and contributors
bluebird 3.5.2	MIT	Copyright (c) 2013-2018 Petka Antonov
bluebird 3.5.1	MIT	Copyright (c) 2013-2015 Petka Antonov
body-parser 1.18.2	MIT	Copyright (c) 2014 Jonathan Ong <me@jongleberry.com> Copyright (c) 2014-2015 Douglas Christopher Wilson <doug@somethingdoug.com>
boom 5.2.0	BSD-3-Clause	Copyright (c) 2012-2014 Walmart and other contributors
boom 4.3.1	BSD-3-Clause	Copyright (c) 2012-2014 Walmart and other contributors
boom 2.10.1	BSD-3-Clause	Copyright (c) 2012-2014 Walmart and other contributors
Boost 1.53.0	BSL-1.0	Copyright (c) 1998-2005 Beman Dawes, David Abrahams Copyright (c) 2004-2007 Rene Rivera
brace-expansion 1.1.8	MIT	Copyright (c) 2013 Julian Gruber <julian@juliangruber.com>
brace-expansion 1.1.11	MIT	Copyright (c) 2013 Julian Gruber <julian@juliangruber.com>
braces 2.3.1	MIT	Copyright (c) 2014-2018 Jon Schlinkert
braces 2.3.0	MIT	
braces 1.8.5	MIT	Copyright (c) 2014-2016 Jon Schlinkert
browser-stdout 1.3.1	MIT	
browsersify-aes 0.4.0	MIT	
browsersify-zlib 0.1.4	MIT	
buffer-from 1.1.1	MIT	Copyright (c) 2016, 2018 Linus Unnebäck
builtin-modules 1.1.1	MIT	Copyright (c) Sindre Sorhus (sindresorhus@gmail.com)

Open Source Software Notice (Cont.)

builtin-status-codes 3.0.0	MIT	Copyright (c) Ben Drucker <bvdrucker@gmail.com> (bendrucker.me)</bvdrucker@gmail.com>
Bytes utility 3.0.0	MIT	Copyright (c) 2012-2014 TJ Holowaychuk <tj@vision-media.ca> Copyright (c) 2015 Jed Watson <jed.watson@me.com>
bzip2 1.0.6	bzip2-1.0.6	
cacache 10.0.4	ISC	Copyright (c) npm, Inc.
cache-base 1.0.1	MIT	Copyright (c) 2014-2017 Jon Schlinkert
call-me-maybe 1.0.1	MIT	Copyright (c) 2015 Eric McCarthy
caller-path 0.1.0	MIT	Copyright (c) Sindre Sorhus <sindresorhus@gmail.com> (sindresorhus.com)
callsites 0.2.0	MIT	Copyright (c) Sindre Sorhus <sindresorhus@gmail.com> (sindresorhus.com)
camelcase 4.1.0	MIT	Copyright (c) Sindre Sorhus <sindresorhus@gmail.com> (sindresorhus.com)
camelcase 3.0.0	MIT	Copyright (c) Sindre Sorhus <sindresorhus@gmail.com> (sindresorhus.com)
camelcase 1.2.1	MIT	Copyright (c) Sindre Sorhus <sindresorhus@gmail.com> (sindresorhus.com)
camelize 1.0.0	MIT	
capture-stack-trace 1.0.0	MIT	Copyright (c) Vsevolod Strukchinsky <floatdrop@gmail.com> (github.com/floatdrop)
cardinal 2.1.1	MIT	Copyright (c) 2012 Thorsten Lorenz
cardinal 1.0.0	MIT	Copyright (c) 2012 Thorsten Lorenz
caseless 0.12.0	Apache-2.0	Copyright (c) Mikeal Rogers <mikeal.rogers@gmail.com>
center-align 0.1.3	MIT	Copyright (c) 2015 Jon Schlinkert
chai 4.2.0	MIT	Copyright (c) 2016 Chai.js Assertion Library
chalk 2.3.0	MIT	Copyright (c) Sindre Sorhus <sindresorhus@gmail.com> (sindresorhus.com) </sindresorhus@gmail.com>
chalk 1.1.3	MIT	Copyright (c) Sindre Sorhus <sindresorhus@gmail.com> (sindresorhus.com)
character-parser 2.2.0	MIT	Copyright (c) 2013 Forbes Lindesay
check-error 1.0.2	MIT	Copyright (c) 2013 Jake Luer <jake@alogicalparadox.com> (http://alogicalparadox.com)</jake@alogicalparadox.com>
chokidar 2.0.0	MIT	Copyright (c) 2012 - 2015 Paul Miller paulmillr.com & Elan Shanker
chokidar 1.7.0	MIT	Copyright (c) 2012-2016 Paul Miller paulmillr.com & Elan Shanker
chownr 1.1.1	ISC	Copyright (c) Isaac Z. Schlueter and Contributors
circular-json 0.3.3	MIT	Copyright (c) 2013-2017 by Andrea Giammarchi - @WebReflection
class-utils 0.3.6	MIT	Copyright (c) 2015, 2017-2018 Jon Schlinkert

Open Source Software Notice (Cont.)

clean-css 3.4.28	MIT	Copyright (c) 2015 JakubPawlowicz.com
cli-boxes 1.0.0	MIT	Copyright (c) Sindre Sorhus <sindresorhus@gmail.com> (sindresorhus.com)</sindresorhus@gmail.com>
cli-cursor 1.0.2	MIT	Copyright (c) Sindre Sorhus <sindresorhus@gmail.com> (sindresorhus.com)
cli-table-redemption 1.0.1	MIT	Copyright (c) 2011-2017 Automattic Copyright (c) 2017 Keymetrics
cli-width 2.2.0	ISC	Copyright (c) 2015 Ilya Radchenko <ilya@burstcreations.com>
cliui 3.2.0	ISC	Copyright (c) 2015 Contributors
cliui 2.1.0	ISC	Copyright (c) 2015 Contributors
co 4.6.0	MIT	Copyright (c) 2014 TJ Holowaychuk &t;tj@vision-media.ca&t;
code-point-at 1.1.0	MIT	Copyright (c) Sindre Sorhus <sindresorhus@gmail.com>
collection-visit 1.0.0	MIT	Copyright (c) 2015-2016 Jon Schlinkert
color-convert 1.9.1	MIT	Copyright (c) 2011-2016 Heather Arthur <fayearthur@gmail.com>
color-name 1.1.3	MIT	Copyright (c) 2015 Dmitry Ivanov
colors 1.3.1	MIT	Copyright (c) Marak Squires Copyright (c) Sindre Sorhus <sindresorhus@gmail.com> (sindresorhus.com)</sindresorhus@gmail.com>
colors 1.3.1	MIT	Copyright (c) Marak Squires Copyright (c) Sindre Sorhus <sindresorhus@gmail.com> (sindresorhus.com)</sindresorhus@gmail.com>
colors 1.0.3	MIT	Original Library - Copyright (c) Marak Squires Additional Functionality - Copyright (c) Sindre Sorhus <sindresorhus@gmail.com> (sindresorhus.com)
colour 0.7.1	MIT	Copyright (c) 2010 Marak Squires, Alexis Sellier (cloudhead) Copyright (c) 2013 Daniel Wirtz <dcode@dcode.io>
commander 2.8.1	MIT	Copyright (c) 2011 TJ Holowaychuk <tj@vision-media.ca>
commander 2.15.1	MIT	Copyright (c) 2011 TJ Holowaychuk <tj@vision-media.ca>
commander 2.13.0	MIT	Copyright (c) 2011 TJ Holowaychuk <tj@vision-media.ca>
commander 2.12.2	MIT	Copyright (c) 2011 TJ Holowaychuk <tj@vision-media.ca>
commonjs-assert 1.4.1	MIT	Copyright Joyent, Inc. and other Node contributors. All rights reserved.
commons-logging	Apache-2.0	
compressible 2.0.12	MIT	Copyright (c) 2013 Jonathan Ong <me@jongleberry.com> Copyright (c) 2014 Jeremiah Senkpiel <fishrock123@rocketmail.com> Copyright (c) 2015 Douglas Christopher Wilson <doug@somethingdoug.com>

Open Source Software Notice (Cont.)

compression 1.7.1	MIT	Copyright (c) 2010 Sencha Inc. Copyright (c) 2011 TJ Holowaychuk Copyright (c) 2014 Jonathan Ong Copyright (c) 2014-2015 Douglas Christopher Wilson
concat-stream 1.6.2	MIT	Copyright (c) 2013 Max Ogden
concat-stream 1.6.0	MIT	Copyright (c) 2013 Max Ogden
concrete5	MIT	Copyright (c) 2011 Concrete CMS inc.
configstore 3.1.2	BSD-2-Clause	Copyright (c) Sindre Sorhus <sindresorhus@gmail.com> (sindresorhus.com)
configstore 3.1.1	BSD-2-Clause	Copyright (c) Google
console-browserify 1.1.0	MIT	Copyright (c) 2012 Raynos
console-control-strings 1.1.0	ISC	Copyright (c) 2014 Rebecca Turner <me@re-becca.org>
constantinople 3.1.0	MIT	Copyright (c) 2013 Forbes Lindesay
content-disposition 0.5.2	MIT	Copyright (c) 2014 Douglas Christopher Wilson
content-type 1.0.4	MIT	Copyright (c) 2014 Douglas Christopher Wilson
convert-source-map 1.6.0	MIT	
cookie 0.3.1	MIT	Copyright (c) 2012-2014 Roman Shtylman <shtylman@gmail.com> Copyright (c) 2015 Douglas Christopher Wilson <doug@something-doug.com>
cookie-parser 1.4.3	MIT	Copyright (c) 2014 TJ Holowaychuk <tj@vision-media.ca>
cookiejar 2.1.2	MIT	Copyright (c) 2013 Bradley Meck
copy-concurrently 1.0.5	ISC	Copyright (c) 2017 Rebecca Turner <me@re-becca.org> </me@re-becca.org>
copy-descriptor 0.1.1	MIT	Copyright (c) 2015-2016 Jon Schlinkert
core-js 2.5.1	MIT	Copyright (c) 2014-2017 Denis Pushkarev
core-util-is 1.0.2	MIT	Copyright (c) Node.js contributors
cors 2.8.4	MIT	Copyright (c) 2013 Troy Goode <troygoode@gmail.com>
crda 1.1.3	ISC	Copyright (c) 2008 Luis R. Rodriguez <mcgrof@gmail.com> Copyright (c) 2008 Johannes Berg <johannes@sipsolutions.net> Copyright (c) 2008 Michael Green <Michael.Green@Atheros.com>
create-error-class 3.0.2	MIT	Copyright (c) Vsevolod Strukchinsky <floatdrop@gmail.com> (github.com/floatdrop)
cron 1.3.0	MIT	Copyright (c) Nick Campbell <nicholas.j.campbell@gmail.com> (http://github.com/ncb000gt)
cronie 1.4.11	BSD-3-Clause	Copyright (c) 1989, 1993 The Regents of the University of California
cross-env 4.0.0	MIT	Copyright (c) 2016 Kent C. Dodds
cross-spawn 5.1.0	MIT	Copyright (c) 2014 IndigoUnited
cryptiles 3.1.2	BSD-3-Clause	Copyright (c) 2012-2013 Eran Hammer
cryptiles 2.0.5	BSD-3-Clause	Copyright (c) 2012-2013 Eran Hammer

Open Source Software Notice (Cont.)

crypto-browserify 3.3.0	MIT	Copyright (c) 2013 Dominic Tarr
crypto-random-string 1.0.0	MIT	Copyright (c) Sindre Sorhus <sindresorhus@gmail.com> (sindresorhus.com)
css-parse 1.7.0	MIT	Copyright (c) 2012 TJ Holowaychuk <tj@vision-media.ca>
curl 7.29.0	curl	
cyclist 0.2.2	MIT	Copyright (c) 2015 Mathias Buus
cyrus-sasl 2.1.26	BSD-like License (cyrus-sasl)	Copyright (c) 1998-2003 Carnegie Mellon University
dasherize 2.0.0	MIT	
date-fns 1.29.0	MIT	Copyright (c) Sasha Koss <koss@nocorp.me>, Leshia Koss <regiusprod@gmail.com>
date-now 0.1.4	MIT	Copyright (c) 2012 Colingo
dbus 1.6.12	AFL-2.1	
dbus-python 1.1.1	MIT	
debug 3.2.5	MIT	Copyright (c) 2014 TJ Holowaychuk <tj@vision-media.ca>
debug 3.1.0	MIT	Copyright (c) 2014 TJ Holowaychuk <tj@vision-media.ca>
debug 3.0.0	MIT	Copyright (c) 2014 TJ Holowaychuk <tj@vision-media.ca>
debug 2.6.9	MIT	Copyright (c) 2014 TJ Holowaychuk <tj@vision-media.ca>
decamelize 1.2.0	MIT	Copyright (c) Sindre Sorhus
decode-uri-component 0.2.0	MIT	Copyright (c) Sam Verschueren <sam.verschueren@gmail.com> (github.com/SamVerschueren)
deep-eql 3.0.1	MIT	Copyright (c) 2013 Jake Luer <jake@alogicalparadox.com> (http://alogicalparadox.com)<jake@alogicalparadox.com>
deep-is 0.1.3	MIT	Copyright (c) 2012, 2013 Thorsten Lorenz <thlorenz@gmx.de> Copyright (c) 2012 James Halliday <mail@substack.net> Copyright (c) 2009 Thomas Robinson <280north.com>
deepmerge 2.1.1	MIT	Copyright (c) 2012 Nicholas Fisher
define-property 2.0.2	MIT	Copyright (c) 2015-2018 Jon Schlinkert
define-property 1.0.0	MIT	Copyright (c) 2015, 2017 Jon Schlinkert
define-property 0.2.5	MIT	Copyright (c) 2015 Jon Schlinkert
del 3.0.0	MIT	
del 2.2.2	MIT	Copyright (c) Sindre Sorhus <sindresorhus@gmail.com> (sindresorhus.com)
denque 1.3.0	Apache-2.0	Copyright (c) 2018 Mike Diarmid (Salakar) <mike.diarmid@gmail.com>
denque 1.2.2	MIT	
deque 2.1.0-0	MIT	Copyright (c) 2013 Petka Antonov
destroy 1.0.4	MIT	Copyright (c) 2014 Jonathan Ong me@jungleberry.com

Open Source Software Notice (Cont.)

detect-indent 4.0.0	MIT	Copyright (c) Sindre Sorhus <sindresorhus@gmail.com> (sindresorhus.com)
detect-libc 1.0.3	Apache-2.0	Copyright 2017 Lovell Fuller
detect-libc 1.0.2	Apache-2.0	
dhcp 4.2.5	ISC	
dir-glob 2.0.0	Apache-2.0	Copyright (c) Kevin Mårtensson <kevinmartensson@gmail.com> (github.com/kevva)
dns-prefetch-control 0.1.0	Apache-2.0	Copyright (c) 2016 Evan Hahn
docker-ce 17.09.0	MIT	
doctrine 2.1.0	MIT	Copyright (c) jQuery Foundation and other contributors
doctypes 1.1.0	MIT	Copyright (c) 2015 Forbes Lindesay
domain-browser 1.2.0	MIT	Copyright (c) 2013+ Bevry Pty Ltd
dont-sniff-mimetype 1.0.0	MIT	Copyright (c) 2014, 2015 Evan Hahn, Adam Baldwin
dot-prop 4.2.0	MIT	Copyright (c) Sindre Sorhus <sindresorhus@gmail.com> (sindresorhus.com)
dotenv 4.0.0	BSD-2-Clause	Copyright (c) 2015 Scott Motte
duplexer 0.1.1	MIT	Copyright (c) 2012 Raynos
duplexer3 0.1.4	BSD-3-Clause	Copyright (c) 2013 Deoxxa Development
duplexify 3.6.0	MIT	
ecc-jsbn 0.1.1	MIT	Copyright (c) 2014 Jeremie Miller
ee-first 1.1.1	MIT	Copyright (c) 2014 Jonathan Ong me@jongleberry.com
ejs 2.5.7	Apache-2.0	Copyright 2112 Matthew Eernisse (mde@fleegix.org)
emitter 1.2.1	MIT	Copyright (c) 2014 Component contributors <dev@component.io>
emitter-listener 1.1.1	BSD-2-Clause	Copyright (c) Forrest L Norvell <ogd@aoaiioxysz.net>
emojis-list 2.1.0	MIT	Copyright (c) 2015 Kiko Beats
encodeurl 1.0.1	MIT	Copyright (c) 2016 Douglas Christopher Wilson
end-of-stream 1.4.1		Copyright (c) 2014 Mathias Buus
enhanced-resolve 0.9.1		Copyright (c) 2012-2013 Tobias Koppers
es5-ext 0.10.38		Copyright (c) 2011-2017 Mariusz Nowak (www.medikoo.com)
es6-iterator 2.0.3		Copyright (c) 2013-2017 Mariusz Nowak (www.medikoo.com)
es6-map 0.1.5		Copyright (c) 2013 Mariusz Nowak (www.medikoo.com)
es6-set 0.1.5		Copyright (c) 2013 Mariusz Nowak (www.medikoo.com)
es6-shim 0.27.1		Copyright (c) 2013-2015 Paul Miller (http://paulmillr.com) and contributors
es6-symbol 3.1.1		Copyright (c) 2013-2015 Mariusz Nowak (www.medikoo.com)
es6-weak-map 2.0.2		Copyright (c) 2013 Mariusz Nowak (www.medikoo.com)

Open Source Software Notice (Cont.)

escape-html 1.0.3	MIT	Copyright (c) 2012-2013 TJ Holowaychuk Copyright (c) 2015 Andreas Lubbe Copyright (c) 2015 Tiancheng "Timothy" Gu
escape-regexp 0.0.1	MIT	
escape-string-regexp 1.0.5	MIT	Copyright (c) Sindre Sorhus <sindresorhus@gmail.com> (sindresorhus.com)
escodegen 1.8.1	BSD-2-Clause	Copyright (c) 2012 [Yusuke Suzuki](http://github.com/Constellation) (twitter: [@Constellation](http://twitter.com/Constellation)) and other contributors
escope 3.6.0	BSD-2-Clause	Copyright (c) 2012-2013 Yusuke Suzuki (twitter: @Constellation) and other contributors
eslint 3.19.0	MIT	Copyright (c) jQuery Foundation and other contributors, https://jquery.org/
esprez 3.5.3	BSD-2-Clause	Copyright (c) JS Foundation and other contributors, https://js.foundation
esprima 4.0.1	BSD-2-Clause	Copyright (c) JS Foundation and other contributors, https://js.foundation/
esprima 4.0.0	BSD-2-Clause	Copyright (c) JS Foundation and other contributors, https://js.foundation/
esprima 3.0.0	BSD-2-Clause	Copyright (c) jQuery Foundation, Inc. and contributors
esprima 2.7.3	BSD-2-Clause	Copyright (c) JS Foundation and other contributors, https://js.foundation/
esquery 1.0.0	BSD-3-Clause	Copyright (c) 2013 Joel Feenstra
Esrecurse 4.2.0	BSD-2-Clause	Copyright (c) 2014 Yusuke Suzuki (twitter: @Constellation) and other contributors
estraverse 4.2.0	BSD-2-Clause	Copyright (c) 2012-2016 Yusuke Suzuki (twitter: @Constellation) and other contributors
estraverse 1.9.3	BSD-2-Clause	Copyright (c) 2012-2016 Yusuke Suzuki (twitter: @Constellation) and other contributors
esutils 2.0.2	BSD-2-Clause	Copyright (c) 2013 Yusuke Suzuki (twitter: @Constellation) and other contributors
etag 1.8.1	MIT	Copyright (c) 2014-2016 Douglas Christopher Wilson
event-emitter 0.3.5	MIT	Copyright (c) 2012-2015, Mariusz Nowak (www.medikoo.com)
event-stream 3.3.4	MIT	Copyright (c) 2011 Dominic Tarr
eventemitter2 1.0.5	MIT	Copyright (c) 2016 Paolo Fragomeni <http://www.github.com/0x00a> and contributors
eventemitter2 0.4.14	MIT	Copyright (c) 2016 Paolo Fragomeni <http://www.github.com/0x00a> and contributors
execa 0.7.0		Copyright (c) Sindre Sorhus <sindresorhus@gmail.com> (sindresorhus.com)
exit-hook 1.1.1		Copyright (c) Sindre Sorhus <sindresorhus@gmail.com> (sindresorhus.com)
expand-brackets 2.1.4		Copyright (c) 2015-2016 Jon Schlinkert

Open Source Software Notice (Cont.)

expand-brackets 0.1.5	MIT	Copyright (c) 2015-2016 Jon Schlinkert
expand-range 1.8.2	MIT	Copyright (c) 2014-2016 Jon Schlinkert
expat 2.1.0	MIT	Copyright (c) 1998, 1999, 2000 Thai Open Source Software Center Ltd and Clark Cooper Copyright (c) 2001, 2002, 2003, 2004, 2005, 2006 Expat maintainers
expect-ct 0.1.0	MIT	Copyright (c) 2017, 2018 Evan Hahn
express 4.16.2	MIT	Copyright (c) 2009-2014 TJ Holowaychuk <tj@vision-media.ca> Copyright (c) 2013-2014 Roman Shtylman <shtylman+expressjs@gmail.com> Copyright (c) 2014-2015 Douglas Christopher Wilson <doug@somethingdoug.com>
express-mysql-session 1.2.2	MIT	Copyright (c) 2014 Charles Hill
express-session 1.15.6	MIT	Copyright (c) 2010 Sencha Inc. Copyright (c) 2011 TJ Holowaychuk <tj@vision-media.ca> Copyright (c) 2014-2015 Douglas Christopher Wilson <doug@somethingdoug.com>
express-shallow 3.0.2	MIT	Copyright (c) 2010 Sencha Inc. Copyright (c) 2011 TJ Holowaychuk <tj@vision-media.ca> Copyright (c) 2014-2015 Douglas Christopher Wilson <doug@somethingdoug.com>
extend-shallow 2.0.1	MIT	Copyright (c) 2014-2015 Jon Schlinkert
extglob 2.0.4	MIT	Copyright (c) 2015-2017 Jon Schlinkert
extglob 0.3.2	MIT	Copyright (c) 2015 Jon Schlinkert
eyes 0.1.8	MIT	
fast-deep-equal 2.0.1	MIT	Copyright (c) 2017 Evgeny Poberezkin
fast-deep-equal 1.0.0	MIT	Copyright (c) 2017 Evgeny Poberezkin
fast-glob 2.1.0	MIT	Copyright (c) Denis Malinochkin
fast-json-stable-stringify 2.0.0	MIT	
fast-levenshtein 2.0.6	MIT	Copyright (c) 2013 Ramesh Nair
fast-safe-stringify 2.0.4	MIT	
fclone 1.0.11	MIT	Copyright (c) 2016 Antoine Bluchet <soyuka@gmail.com>
fecha 2.3.3	MIT	Copyright (c) 2015 Taylor Hakes
feross-buffer 4.9.1	MIT	Copyright (c) Feross Aboukhadijeh and other contributors
figures 1.7.0	MIT	Copyright (c) Sindre Sorhus <sindresorhus@gmail.com> (sindresorhus.com)
file 5.11	BSD-like License (file)	Copyright (c) 1986, 1987, 1989, 1990, 1991, 1992, 1994, 1995 Ian F. Darwin Software written by Ian F. Darwin and others; maintained 1994-Christos Zoulas
file-entry-cache 2.0.0	MIT	Copyright (c) 2015 Roy Riojas
file-stream-rotator 0.2.1	MIT	

Open Source Software Notice (Cont.)

filename-regex 2.0.1	MIT	Copyright (c) 2014-2015 Jon Schlinkert
fill-keys 1.0.2	MIT	Copyright (c) Ben Drucker <bvdrucker@gmail.com> (bendrucker.me)</bvdrucker@gmail.com>
fill-range 4.0.0	MIT	Copyright (c) 2014-2016 Jon Schlinkert
fill-range 2.2.3	MIT	Copyright (c) 2014-2015 Jon Schlinkert
finalhandler 1.1.0	MIT	Copyright (c) 2014-2017 Douglas Christopher Wilson <doug@somethingdoug.com>
find-cache-dir 1.0.0	MIT	Copyright (c) James Talmage <james@talmage.io> (github.com/jamestalmage)</james@talmage.io>
find-cache-dir 0.1.1	MIT	Copyright (c) James Talmage <james@talmage.io> (github.com/jamestalmage)
find-up 2.1.0	MIT	Copyright (c) Sindre Sorhus <sindresorhus@gmail.com> (sindresorhus.com)
find-up 1.1.2	MIT	Copyright (c) Sindre Sorhus <sindresorhus@gmail.com> (sindresorhus.com)
fipscheck 1.4.1	BSD-2-Clause-FreeBSD	Copyright (c) 2008-2012 Red Hat, Inc.
flat-cache 1.3.0	MIT	Copyright (c) 2015 Roy Riojas
flush-write-stream 1.0.3	MIT	Copyright (c) 2015 Mathias Buus
fontconfig 2.10.95	MIT-like License (fontconfig)	Copyright (c) 2000, 2001, 2002, 2003, 2004, 2006, 2007 Keith Packard Copyright (c) 2005 Patrick Lam Copyright (c) 2009 Roozbeh Pournader Copyright (c) 2008, 2009 Red Hat, Inc. Copyright (c) 2008 Danilo Šegan Copyright (c) 2012 Google, Inc.
for-in 1.0.2	MIT	Copyright (c) 2014-2016 Jon Schlinkert
for-own 0.1.5	MIT	Copyright (c) 2014-2015 Jon Schlinkert
forever-agent 0.6.1	Apache-2.0	Copyright (c) 2010-2012, Christian Johansen (christian@cjohansen.no) and August Lilleaas (august.lilleaas@gmail.com)
Form-Data 2.3.2	MIT	Copyright (c) 2012 Felix Geisendörfer (felix@debuggable.com) and contributors
form-data 2.3.1	MIT	Copyright (c) 2012 Felix Geisendörfer (felix@debuggable.com) and contributors
form-data 2.1.4	MIT	Copyright (c) 2012 Felix Geisendörfer (felix@debuggable.com) and contributors
formatio 2.0.0	BSD-3-Clause	Copyright (c) 2010-2012, Christian Johansen (christian@cjohansen.no) and August Lilleaas (august.lilleaas@gmail.com)
forwarded 0.1.2	MIT	Copyright (c) 2014 Douglas Christopher Wilson
fragment-cache 0.2.1	MIT	Copyright (c) 2016-2017 Jon Schlinkert
frameguard 3.0.0	MIT	Copyright (c) 2014-2016 Evan Hahn, Adam Baldwin
freetype 2.4.11	FTL	Copyright (c) 2006-2015 David Turner, Robert Wilhelm, and Werner Lemberg

Open Source Software Notice (Cont.)

fresh 0.5.2	MIT	Copyright (c) 2012 TJ Holowaychuk <tj@vision-media.ca> Copyright (c) 2016-2017 Douglas Christopher Wilson <doug@somethingdoug.com>
from 0.1.7	MIT	
from2 2.3.0	MIT	Copyright (c) 2014 Hugh Kennedy
fs-promise 2.0.3	MIT	Copyright (c) 2013 Kevin Beaty
fs-write-stream-atomic 1.0.10	ISC	Copyright (c) Isaac Z. Schlueter and contributors
fs.realpath 1.0.0	ISC	Copyright (c) Isaac Z. Schlueter and contributors
fstream 1.0.11	ISC	Copyright (c) Isaac Z. Schlueter and contributors
fstream-ignore 1.0.5	ISC	Copyright (c) Isaac Z. Schlueter and contributors
function-bind 1.1.1	MIT	Copyright (c) 2013 Raynos
gauge 2.7.4	ISC	Copyright (c) 2014 Rebecca Turner <me@re-becca.org>
generate-function 2.0.0	MIT	Copyright (c) 2014 Mathias Buus
generate-object-property 1.2.0	MIT	Copyright (c) 2014 Mathias Buus
get-caller-file 1.0.2	ISC	Copyright (c) Stefan Penner
get-func-name 2.0.0	MIT	Copyright (c) 2013 Jake Luer <jake@alogicalparadox.com> (http://alogicalparadox.com)<jake@alogicalparadox.com>
get-stream 3.0.0	MIT	Copyright (c) Sindre Sorhus <sindresorhus@gmail.com> (sindresorhus.com)
get-value 2.0.6	MIT	Copyright (c) 2014-2016 Jon Schlinkert
getenv 0.7.0	MIT	Copyright (c) Christoph Tavan <dev@tavan.de>
giflib 4.1.6	MIT	Copyright (c) 1997 Eric S. Raymond
gkt 1.0.0	MIT	
glob-base 0.3.0	MIT	Copyright (c) 2015 Jon Schlinkert
glob-parent 3.1.0	ISC	Copyright (c) 2015 Elan Shanker
glob-parent 2.0.0	ISC	Copyright (c) 2015 Elan Shanker
glob-to-regexp 0.3.0	BSD-2-Clause	Copyright (c) 2013 Nick Fitzgerald
global-dirs 0.1.1	MIT	Copyright (c) Sindre Sorhus <sindresorhus@gmail.com> (sindresorhus.com)<sindresorhus@gmail.com>
globals 9.18.0	MIT	Copyright (c) Sindre Sorhus <sindresorhus@gmail.com> (sindresorhus.com)
globby 8.0.1	MIT	Copyright (c) Sindre Sorhus <sindresorhus@gmail.com> (sindresorhus.com)
globby 6.1.0	MIT	Copyright (c) Sindre Sorhus <sindresorhus@gmail.com> (sindresorhus.com)<sindresorhus@gmail.com>
globby 5.0.0	MIT	Copyright (c) Sindre Sorhus <sindresorhus@gmail.com> (sindresorhus.com)
got 6.7.1	MIT	Copyright (c) Sindre Sorhus <sindresorhus@gmail.com> (sindresorhus.com)<sindresorhus@gmail.com>
Gozala-events 1.1.1	MIT	Copyright (c) Joyent, Inc. and other Node contributors

Open Source Software Notice (Cont.)

graceful-readlink 1.0.1	MIT	Copyright (c) 2015 Zhiye Li
growl 1.10.5	MIT	
gsm 1.0.13	MIT	
handlebars.js 4.0.11	MIT	
har-schema 2.0.0	ISC	Copyright (c) 2015 Ahmad Nassri <ahmad@ahmadnassri.com>
har-schema 1.0.5	ISC	Copyright (c) 2015 Ahmad Nassri <ahmad@ahmadnassri.com>
har-validator 5.0.3	ISC	Copyright (c) 2015 Ahmad Nassri <ahmad@ahmadnassri.com>
har-validator 4.2.1	ISC	Copyright (c) 2015 Ahmad Nassri <ahmad@ahmadnassri.com>
harfbuzz 0.9.36	MIT-like License (HarfBuzz)	
has 1.0.1	MIT	Copyright (c) 2013 Thiago de Arruda
has-ansi 2.0.0	MIT	Copyright (c) Sindre Sorhus <sindresorhus@gmail.com> (sindresorhus.com)
has-flag 3.0.0	MIT	Copyright (c) Sindre Sorhus <sindresorhus@gmail.com> (sindresorhus.com)
has-flag 2.0.0	MIT	Copyright (c) Sindre Sorhus <sindresorhus@gmail.com> (sindresorhus.com)</sindresorhus@gmail.com>
has-flag 1.0.0	MIT	Copyright (c) Sindre Sorhus <sindresorhus@gmail.com> (sindresorhus.com)
has-unicode 2.0.1	ISC	Copyright (c) 2014 Rebecca Turner <me@re-becca.org>
has-value 1.0.0	MIT	Copyright (c) 2014-2017 Jon Schlinkert
has-value 0.3.1	MIT	Copyright (c) 2014-2015 Jon Schlinkert
has-values 1.0.0	MIT	Copyright (c) 2014-2017 Jon Schlinkert
has-values 0.1.4	MIT	Copyright (c) 2014-2015 Jon Schlinkert
hawk 6.0.2	BSD-3-Clause	Copyright (c) 2012-2013 Eran Hammer
hawk 3.1.3	BSD-3-Clause	Copyright (c) 2012-2013 Eran Hammer
he 1.1.1	MIT	Copyright (c) Mathias Bynens <https://mathiasbynens.be/>
helmet 3.12.0	MIT	Copyright (c) 2012-2018 Evan Hahn, Adam Baldwin
helmet-csp 2.7.0	MIT	Copyright (c) 2014-2018 Evan Hahn, Adam Baldwin
hide-powered-by 1.0.0	MIT	Copyright (c) 2014, 2015 Evan Hahn, Adam Baldwin
hoek 4.2.0	BSD-3-Clause	Copyright (c) 2011-2013 Walmart
hoek 2.16.3	BSD-3-Clause	Copyright (c) 2011-2013 Walmart
home-or-tmp 2.0.0	MIT	Copyright (c) Sindre Sorhus <sindresorhus@gmail.com> (sindresorhus.com)
hosted-git-info 2.5.0	ISC	Copyright (c) 2015 Rebecca Turner
hpkp 2.0.0	MIT	Copyright (c) 2015-2016 Evan Hahn, Adam Baldwin
hsts 2.1.0	MIT	Copyright (c) 2014-2017 Evan Hahn, Adam Baldwin

Open Source Software Notice (Cont.)

hoek 4.2.0	BSD-3-Clause	Copyright (c) 2011-2013 Walmart
http-errors 1.6.2	MIT	Copyright (c) 2014 Jonathan Ong me@jongleberry.com Copyright (c) 2016 Douglas Christopher Wilson doug@something-doug.com
httpd 2.4.6	Apache-2.0	Copyright (c) 1997-2015 The Apache Software Foundation
httpd 2.4.20	Apache-2.0	Copyright (c) 1997-2015 The Apache Software Foundation
httpd 2.4.18	Apache-2.0	Copyright (c) 1997-2015 The Apache Software Foundation
https-browserify 0.0.1	MIT	
iconv-lite 0.4.19	MIT	Copyright (c) 2011 Alexander Shtuchkin
icu 50.1.2	ICU	Copyright (c) 1995-2010 International Business Machines Corporation and others
ieee754 1.1.8	BSD-3-Clause	Copyright (c) 2008 Fair Oaks Labs, Inc.
ienoopen 1.0.0	MIT	Copyright (c) 2014, 2015 Evan Hahn, Adam Baldwin
iferr 0.1.5	MIT	Copyright (c) 2014 Nadav Ivgi
ignore 3.3.7	MIT	Copyright (c) 2013 Kael Zhang <i@kael.me>, contributors. http://kael.me/
ignore-by-default 1.0.1	ISC	Copyright (c) 2016, Mark Wubben
ignore-loader 0.1.2	MIT	Copyright (c) 2016 Cherry Ng
ilmbase 1.0.3	BSD-3-Clause	Copyright (c) 2002-2011, Industrial Light & Magic, a division of Lucasfilm Entertainment Company Ltd.
ImageMagick 6.7.8.9	ImageMagick	
import-fresh 1.0.3	MIT	Copyright (c) Sindre Sorhus <sindresorhus@gmail.com> (sindresorhus.com)
import-lazy 2.1.0	MIT	Copyright (c) Sindre Sorhus <sindresorhus@gmail.com> (sindresorhus.com)</sindresorhus@gmail.com>
imurmurhash-js 0.1.4	MIT	Copyright (c) 2013 Gary Court, Jens Taylor
indexof 0.0.1	MIT	Copyright (c) 2012 TJ Holowaychuk
inflight 1.0.6	ISC	Copyright (c) Isaac Z. Schlueter
inherits 2.0.3	ISC	Copyright (c) Isaac Z. Schlueter
inherits 2.0.1	ISC	Copyright (c) Isaac Z. Schlueter
ini 1.3.5	ISC	Copyright (c) Isaac Z. Schlueter
ini 1.3.4	ISC	Copyright (c) Isaac Z. Schlueter and contributors
Inquirer.js 0.12.0	MIT	Copyright (c) 2012 Simon Boudrias
interpret 1.1.0	MIT	Copyright (c) 2014 Tyler Kellen
interpret 0.6.6	MIT	Copyright (c) 2014 Tyler Kellen
invariant 2.2.4	MIT	Copyright (c) 2013-present, Facebook, Inc.
invert-kv 1.0.0	MIT	Copyright (c) Sindre Sorhus <sindresorhus@gmail.com> (sindresorhus.com)
ipaddr.js 1.5.2	MIT	Copyright (c) 2011 Peter Zotov <whitequark@whitequark.org>

Open Source Software Notice (Cont.)

is 3.2.1	MIT	Copyright (c) 2013 Enrico Marino Copyright (c) 2014 Enrico Marino and Jordan Harband
is-accessor-descriptor 1.0.0	MIT	Copyright (c) 2015-2017 Jon Schlinkert
is-accessor-descriptor 0.1.6	MIT	Copyright (c) 2015 Jon Schlinkert
is-binary-path 1.0.1	MIT	Copyright (c) Sindre Sorhus <sindresorhus@gmail.com> (sindresorhus.com)
is-buffer 1.1.6	MIT	Copyright (c) Feross Aboukhadijeh
is-builtin-module 1.0.0	MIT	Copyright (c) Sindre Sorhus <sindresorhus@gmail.com> (sindresorhus.com)
is-data-descriptor 1.0.0	MIT	Copyright (c) 2015-2017 Jon Schlinkert
is-data-descriptor 0.1.4	MIT	Copyright (c) 2015 Jon Schlinkert
is-descriptor 1.0.2	MIT	Copyright (c) 2015-2017 Jon Schlinkert
is-descriptor 0.1.6	MIT	Copyright (c) 2015-2017 Jon Schlinkert
is-dotfile 1.0.3	MIT	Copyright (c) 2015 Jon Schlinkert
is-equal-shallow 0.1.3	MIT	Copyright (c) 2015 Jon Schlinkert
is-expression 3.0.0	MIT	Copyright (c) 2015 Tiancheng "Timothy" Gu
is-expression 2.1.0	MIT	Copyright (c) 2015 Tiancheng "Timothy" Gu
is-extendable 1.0.1	MIT	Copyright (c) 2015-2017 Jon Schlinkert
is-extendable 0.1.1	MIT	Copyright (c) 2015 Jon Schlinkert
is-extglob 2.1.1	MIT	Copyright (c) 2014-2015 Jon Schlinkert
is-extglob 1.0.0	MIT	Copyright (c) 2014-2015 Jon Schlinkert
is-finite 1.0.2	MIT	Copyright (c) Sindre Sorhus <sindresorhus@gmail.com> (sindresorhus.com)
is-fullwidth-code-point 2.0.0	MIT	Copyright (c) Sindre Sorhus <sindresorhus@gmail.com> (sindresorhus.com)
is-fullwidth-code-point 1.0.0	MIT	Copyright (c) Sindre Sorhus <sindresorhus@gmail.com> (sindresorhus.com)
is-glob 4.0.0	MIT	Copyright (c) 2014-2017 Jon Schlinkert
is-glob 3.1.0	MIT	Copyright (c) 2014-2015 Jon Schlinkert
is-glob 2.0.1	MIT	Copyright (c) 2014-2015 Jon Schlinkert
is-installed-globally 0.1.0	MIT	Copyright (c) Sindre Sorhus <sindresorhus@gmail.com> (sindresorhus.com)</sindresorhus@gmail.com>
is-my-json-valid 2.17.1	MIT	Copyright (c) 2014 Mathias Buus
is-npm 1.0.0	MIT	
is-number 4.0.0	MIT	Copyright (c) 2014-2017 Jon Schlinkert
is-number 3.0.0	MIT	Copyright (c) 2014-2015 Jon Schlinkert
is-number 2.1.0	MIT	Copyright (c) 2014-2015 Jon Schlinkert
is-obj 1.0.1	MIT	Copyright (c) Sindre Sorhus <sindresorhus@gmail.com> (sindresorhus.com)

Open Source Software Notice (Cont.)

is-object 1.0.1	MIT	Copyright (c) 2013 Colingo
is-odd 2.0.0	MIT	Copyright (c) 2015-2017 Jon Schlinkert
is-odd 1.0.0	MIT	
is-path-cwd 1.0.0	MIT	Copyright (c) Sindre Sorhus <sindresorhus@gmail.com> (sindresorhus.com)
is-path-in-cwd 1.0.0	MIT	Copyright (c) Sindre Sorhus <sindresorhus@gmail.com> (sindresorhus.com)
is-path-inside 1.0.1	MIT	Copyright (c) Sindre Sorhus <sindresorhus@gmail.com> (sindresorhus.com)
is-plain-object 2.0.4	MIT	Copyright (c) 2014-2017 Jon Schlinkert
is-posix-bracket 0.1.1	MIT	Copyright (c) 2014-2016 Jon Schlinkert
is-primitive 2.0.0	MIT	Copyright (c) 2014-2015 Jon Schlinkert
is-promise 2.1.0	MIT	Copyright (c) 2014 Forbes Lindesay
is-property 1.0.2	MIT	Copyright (c) 2013 Mikola Lysenko
is-redirect 1.0.0	MIT	Copyright (c) Sindre Sorhus <sindresorhus@gmail.com> (sindresorhus.com)</sindresorhus@gmail.com>
is-regex 1.0.4	MIT	Copyright (c) 2014 Jordan Harband
is-resolvable 1.1.0	ISC	Copyright (c) 2018 Shinnosuke Watanabe
is-retry-allowed 1.1.0	MIT	Copyright (c) Vsevolod Strukchinsky <floatdrop@gmail.com> (github.com/floatdrop)</floatdrop@gmail.com>
is-stream 1.1.0	MIT	Copyright (c) Sindre Sorhus <sindresorhus@gmail.com> (sindresorhus.com)
is-typedarray 1.0.0	MIT	Copyright (c) Hugh Kennedy <hughskennedy@gmail.com> (http://hughsk.io/)
is-utf8 0.2.1	MIT	Copyright (c) 2014 Wei Fanzhe
is-windows 1.0.2	MIT	Copyright (c) 2015-2018 Jon Schlinkert
is-windows 1.0.1	MIT	Copyright (c) 2015-2017 Jon Schlinkert
isarray 1.0.0	MIT	Copyright (c) 2013 Julian Gruber <julian@juliangruber.com>
isarray 0.0.1	MIT	Copyright (c) 2013 Julian Gruber <julian@juliangruber.com>
isemail 2.2.1	BSD-3-Clause	Copyright (c) 2014-2015 Eli Skeggs and Project contributors Copyright (c) 2013-2014 GlobeSherpa Copyright (c) 2008-2011 Dominic Sayers
isexe 2.0.0	ISC	Copyright (c) Isaac Z. Schlueter and contributors
isobject 3.0.1	MIT	Copyright (c) 2014-2017 Jon Schlinkert
isobject 2.1.0	MIT	Copyright (c) 2014-2016 Jon Schlinkert
isstream 0.1.2	MIT	Copyright (c) 2015 Rod Vagg
istanbul 0.4.5	BSD-3-Clause	Copyright (c) 2012 Yahoo! Inc.
items 2.1.1	BSD-3-Clause	Copyright (c) 2014-2016 Project contributors Copyright (c) 2014 Walmart Copyright (c) 2010-2014 Caolan McMahon

Open Source Software Notice (Cont.)

iw 3.1	ISC	Copyright (c) 2007, 2008 Johannes Berg Copyright (c) 2007 Andy Lutomirski Copyright (c) 2007 Mike Kershaw Copyright (c) 2008-2009 Luis R. Rodriguez
Jansson 2.4	MIT	Copyright (c) 2009-2014 Petri Lehtinen <petri@digip.org>
jasper 1.900.1	JasPer-2.0	
javapackages 3.4.1	BSD-3-Clause	
jemalloc 3.6.0	BSD-2-Clause	Copyright (c) 2002-2016 Jason Evans <jasone@canonware.com> Copyright (c) 2007-2012 Mozilla Foundation Copyright (c) 2009-2016 Facebook, Inc.
joi 12.0.0	BSD-3-Clause	Copyright (c) 2012-2017 Project contributors Copyright (c) 2012-2014 Walmart
joi 10.6.0	BSD-3-Clause	Copyright (c) 2012-2017 Project contributors Copyright (c) 2012-2014 Walmart
jonschlinkert-use 2.0.2	MIT	Copyright (c) 2015-2017 Jon Schlinkert
js-stringify 1.0.2	MIT	Copyright (c) 2014 Forbes Lindesay
js-tokens 4.0.0	MIT	
js-tokens 3.0.2	MIT	Copyright (c) 2014, 2015, 2016, 2017 Simon Lydell
js-yaml 3.10.0	MIT	Copyright (c) 2011-2015 by Vitaly Puzrin
jsbn 0.1.1	MIT-like License (jsbn)	Copyright (c) 2003-2005 Tom Wu
jsdiff 3.5.0	BSD-3-Clause	
jsdiff 3.4.0	BSD-3-Clause	
jsesc 1.3.0	MIT	Copyright (c) Mathias Bynens < https://mathiasbynens.be/ >
jsesc 0.5.0	MIT	
json-c 0.11	MIT	Copyright (c) 2009-2012 Eric Haszlakiewicz
json-schema 0.2.3	AFL-2.1	Copyright (c) Kris Zyp
json-schema-traverse 0.4.1	MIT	Copyright (c) 2017 Evgeny Poberezkin
json-schema-traverse 0.3.1	MIT	Copyright (c) 2017 Evgeny Poberezkin
json-stable-stringify 1.0.1	MIT	Copyright (c) James Halliday < mail@substack.net >
json-stringify-safe 5.0.1	ISC	Copyright (c) Isaac Z. Schlueter and contributors
json5 0.5.1	MIT	Copyright (c) 2012-2016 Aseem Kishore and others
jsonpointer 4.0.1	MIT	Copyright (c) 2011-2015 Jan Lehnardt jan@apache.org & Marc Bachmann https://github.com/marcbachmann
jstransformer 1.0.0	MIT	Copyright (c) 2015 Forbes Lindesay
just 1.1.27	MIT	Copyright (c) 2016 angus croll
kind-of 6.0.2	MIT	Copyright (c) 2014-2017 Jon Schlinkert
kind-of 5.1.0	MIT	Copyright (c) 2014-2017 Jon Schlinkert
kind-of 4.0.0	MIT	Copyright (c) 2014-2017 Jon Schlinkert

Open Source Software Notice (Cont.)

kind-of 3.2.2	MIT	Copyright (c) 2014-2017 Jon Schlinkert
krb5 1.13.2	MIT-like License (krb5)	
kue 0.11.6	MIT	Copyright (c) 2011 LearnBoost <tj@learnboost.com>
latest-version 3.1.0	MIT	Copyright (c) Sindre Sorhus <sindresorhus@gmail.com> (sindresorhus.com)</sindresorhus@gmail.com>
lazy 1.0.11	MIT	Copyright (c) 2012 - 2017 Daniel 'Eisbehr' Kern
lazy-cache 2.0.2	MIT	Copyright (c) 2015-2016 Jon Schlinkert
lazy-cache 1.0.4	MIT	Copyright (c) 2015-2016 Jon Schlinkert
lcid 1.0.0	MIT	Copyright (c) Sindre Sorhus <sindresorhus@gmail.com> (sindresorhus.com)
less 458	Less	Copyright (c) 1984-2015 Mark Nudelman
levn 0.3.0	MIT	Copyright (c) George Zahariev
libcap 2.22	BSD-3-Clause	
libcom_err 1.42.9	MIT	
libdrm 2.4.60	MIT	Copyright (c) 1999 Precision Insight, Inc., Cedar Park, Texas Copyright (c) 2000 VA Linux Systems, Inc., Sunnyvale, California
libedit 3	BSD-3-Clause	Copyright (c) 1999 Precision Insight, Inc., Cedar Park, Texas Copyright (c) 2000 VA Linux Systems, Inc., Sunnyvale, California
libffi 3.0.13	MIT	Copyright (c) 1996-2012 Anthony Green, Red Hat, Inc and others
libfontenc 1.1.2	MIT	Copyright (c) 1998-2001 by Juliusz Chroboczek
libjpeg-turbo 1.2.90	IJG	Copyright (c) 2009-2016 D. R. Commander
libogg 1.3.0	BSD-3-Clause	Copyright (c) 2002 Xiph.Org.
libpcap 1.5.3	BSD-3-Clause	Copyright (c) 1993, 1994, 1995, 1996, 1997, 1998 The Regents of the University of California
libpng 1.5.13	Libpng	Copyright (c) 1998-2014 Glenn Randers-Pehrson Copyright (c) 1996, 1997 Andreas Dilger Copyright (c) 1995, 1996 Guy Eric Schalnat, Group 42, Inc.
libss 1.42.9	MIT-like License (libss)	Copyright (c) 1987, 1988 MIT Student Information Processing Board
libssh2 1.4.3	BSD-3-Clause	Copyright (c) 2004-2007 Sara Golemon <sarag@libssh2.org> Copyright (c) 2005, 2006 Mikhail Gusarov <dottedmag@dottedmag.net> Copyright (c) 2006-2007 The Written Word, Inc. Copyright (c) 2007 Eli Fant <elifantu@mail.ru> Copyright (c) 2009 Daniel Stenberg Copyright (c) 2008, 2009 Simon Josefsson
libtar 1.2.11	NCSA	Copyright (c) 1998-2003 University of Illinois Board of Trustees Copyright (c) 1998-2003 Mark D. Roth
libuuid 2.23.2	BSD-3-Clause	Copyright (c) 1996, 1997 Theodore Ts'o
libverto 0.2.5	MIT	

Open Source Software Notice (Cont.)

libvorbis 1.3.3	BSD-3-Clause	Copyright (c) 2002-2008 Xiph.org Foundation
libvpx 1.3.0	BSD-3-Clause	Copyright (c) 2010 The WebM Project authors
libX11 1.6.3	X11	Copyright (c) 2003-2006, 2008 Jamey Sharp, Josh Triplett Copyright (c) 2009, Red Hat, Inc. Copyright (c) 1990-1992, 1999-2000, 2004, 2009-2010 Oracle and/or its affiliates Copyright (c) 1984-1994, 1998 The Open Group Copyright (c) 1985, 1986, 1987, 1988, 1989, 1990, 1991, 1994, 1996 X Consortium Copyright (c) 2000 The XFree86 Project, Inc. Copyright (c) 1990, 1991 Tektronix, Inc. Copyright (c) 1999-2000 Free Software Foundation, Inc. Copyright (c) 1992 Oki Technosystems Laboratory, Inc. Copyright (c) 1990-1995 FUJITSU LIMITED Copyright (c) 1995 David E. Wexelblat. All rights reserved Copyright (c) 1990 1991, OMRON Corporation Copyright (c) 1991 the Open Software Foundation Copyright (c) 1993, 1994 Sony Corporation Copyright (c) 1993, 1995 Silicon Graphics Computer Systems, Inc. Copyright (c) 1993 Fujitsu Open Systems Solutions, Inc. Copyright (c) 1987, 1988, 1990, 1993 Digital Equipment Corporation Copyright (c) 1993 SunSoft, Inc. Copyright (c) 1999-2000 Bruno Haible Copyright (c) 1990, 1991 OMRON Corporation, NTT Software Corporation, Copyright (c) 1988 Wyse Technology, Inc., San Jose, Ca, Copyright (c) 1991-1992 Fuji Xerox Co., Ltd. Copyright (c) 1996 Sebastien Marineau and Holger Veit Copyright (c) 2000 Bruno Haible Copyright (c) 2003 Keith Packard Copyright (c) 2007-2009 Troy D. Hanson Copyright (c) 1992, 1993 TOSHIBA Corp. Copyright (c) 1993 IBM Corporation
libxml2 2.9.1	MIT	Copyright (c) 1998-2003 Daniel Veillard
libxslt 1.1.28	X11	Copyright (c) 2001-2002 Thomas Broyer, Charlie Bozeman and Daniel Veillard
Linux-PAM 1.1.8	BSD-3-Clause	Copyright (c) YEAR Linux-PAM Project Copyright (c) 1997 Andrew G. Morgan <morgan@parc.power.net>
Little CMS 2.6	MIT	Copyright (c) 1998-2011 Marti Maria Saguer
load-json-file 1.1.0	MIT	Copyright (c) Sindre Sorhus <sindresorhus@gmail.com> (sindresorhus.com)
loader-utils 0.2.17	MIT	Copyright (c) 2012 - 2015 Tobias Koppers
locate-path 2.0.0	MIT	Copyright (c) Sindre Sorhus <sindresorhus@gmail.com> (sindresorhus.com)
lodash 4.6.1	MIT	Copyright (c) 2012-2015 The Dojo Foundation <http://dojofoundation.org/> Based on Underscore.js, copyright 2009-2015 Jeremy Ashkenas, DocumentCloud and Investigative Reporters & Editors <http://underscorejs.org/>

Open Source Software Notice (Cont.)

lodash 4.6.0	MIT	Copyright (c) JS Foundation and other contributors < https://js.foundation/ >
lodash 4.5.0	MIT	Copyright (c) JS Foundation and other contributors < https://js.foundation/ >
lodash 4.4.2	MIT	Copyright (c) JS Foundation and other contributors < https://js.foundation/ >
lodash 4.2.0	MIT	Copyright (c) JS Foundation and other contributors < https://js.foundation/ >
lodash 4.17.5	MIT	Copyright (c) JS Foundation and other contributors < https://js.foundation/ >
lodash 4.17.11	MIT	Copyright (c) JS Foundation and other contributors < https://js.foundation/ >
logform 1.9.1	MIT	Copyright (c) 2017 Charlie Robbins & the contributors
lolex 2.3.2	BSD-3-Clause	Copyright (c) 2010-2014 Christian Johansen, christian@cjohansen.no. All rights reserved.
long 4.0.0	Apache-2.0	
long 3.2.0	Apache-2.0	
longest 1.0.1	MIT	Copyright (c) 2014-2015 Jon Schlinkert
lowercase-keys 1.0.0	MIT	Copyright (c) Sindre Sorhus < sindresorhus@gmail.com > (sindresorhus.com)< sindresorhus@gmail.com >
lsif 4.87	MIT-like License (lsif)	Copyright (c) 2002 Purdue Research Foundation
Lua 5.1.4	MIT	Copyright (c) 1994-2008 Lua.org, PUC-Rio
lzma-native 3.0.1	MIT	Copyright (c) 2014-2016 Anna Henningsen
mailx 12.5	BSD-4-Clause	
make-dir 1.3.0	MIT	Copyright (c) Sindre Sorhus < sindresorhus@gmail.com > (sindresorhus.com)
map-cache 0.2.2	MIT	Copyright (c) 2015-2016 Jon Schlinkert
map-stream 0.1.0	MIT	Copyright (c) 2011 Dominic Tarr
map-visit 1.0.0	MIT	Copyright (c) 2015-2016 Jon Schlinkert
media-typer 0.3.0	MIT	Copyright (c) 2014 Douglas Christopher Wilson
medikoo-d 1.0.0	MIT	Copyright (c) 2013 Mariusz Nowak (www.medikoo.com)
memory-fs 0.3.0	MIT	Copyright (c) 2012-2014 Tobias Koppers
memory-fs 0.2.0	MIT	Copyright (c) 2012-2014 Tobias Koppers
merge-descriptors 1.0.1	MIT	Copyright (c) 2013 Jonathan Ong < me@jongleberry.com > Copyright (c) 2015 Douglas Christopher Wilson < doug@somethingdoug.com >
merge2 1.2.1	MIT	Copyright (c) 2014-2018 Teambition
Mesa3D 10.6.5	MIT	

Open Source Software Notice (Cont.)

methods 1.1.2	MIT	Copyright (c) 2013-2014 TJ Holowaychuk <tj@vision-media.ca> Copyright (c) 2015-2016 Douglas Christopher Wilson <doug@somethingdoug.com>
micromatch 3.1.9	MIT	Copyright (c) 2014-2015 Jon Schlinkert
micromatch 3.1.5	MIT	
micromatch 2.3.11	MIT	Copyright (c) 2014-2015 Jon Schlinkert
mime-db 1.36.0	MIT	Copyright (c) 2014 Jonathan Ong me@jongleberry.com
mime-db 1.32.0	MIT	
mime-db 1.30.0	MIT	Copyright (c) 2014 Jonathan Ong me@jongleberry.com
mime-types 2.1.20	MIT	Copyright (c) 2014 Jonathan Ong <me@jongleberry.com> Copyright (c) 2015 Douglas Christopher Wilson <doug@somethingdoug.com>
mime-types 2.1.17	MIT	Copyright (c) 2014 Jonathan Ong <me@jongleberry.com> Copyright (c) 2015 Douglas Christopher Wilson <doug@somethingdoug.com>
minimatch 3.0.4	ISC	Copyright (c) 2009, 2010, 2011 Isaac Z. Schlueter
minimist 1.2.0	MIT	
minimist 0.0.8	MIT	
minimist 0.0.10	MIT	
minimum-tls-version 0.0.3	MIT	
mississippi 2.0.0	BSD-2-Clause	
mixin-deep 1.3.0	MIT	
mocha 5.2.0	MIT	
module-not-found-error 1.0.1	MIT	Copyright (c) Ben Drucker <bvdrucker@gmail.com> (bendrucker.me)</bvdrucker@gmail.com>
moment 2.22.2	MIT	Copyright (c) JS Foundation and other contributors
moment 2.20.1	MIT	Copyright (c) JS Foundation and other contributors
moment-timezone 0.5.14	MIT	Copyright (c) JS Foundation and other contributors
morgan 1.9.0	MIT	Copyright (c) 2014 Jonathan Ong <me@jongleberry.com> Copyright (c) 2014-2015 Douglas Christopher Wilson <doug@somethingdoug.com>
move-concurrently 1.0.1	ISC	Copyright (c) 2017, Rebecca Turner <me@re-becca.org></me@re-becca.org>
mrmInC-readdir-enhanced 2.2.1	MIT	Copyright (c) 2016 James Messinger
ms.js 2.1.1	MIT	Copyright (c) 2016 Zeit, Inc.
ms.js 2.0.0	MIT	Copyright (c) 2016 Zeit, Inc.
mute-stream 0.0.7	ISC	Copyright (c) Isaac Z. Schlueter and contributors
mute-stream 0.0.5	ISC	Copyright (c) Isaac Z. Schlueter and contributors
mysqldump 2.2.1	MIT	Copyright (c) 2017 Brad Zacher and contributors

Open Source Software Notice (Cont.)

mysqljs-mysql 2.14.1	MIT	Copyright (c) 2012 Felix Geisendörfer (felix@debuggable.com) and contributors
mz 2.7.0	MIT	Copyright (c) 2014 Jonathan Ong me@jongleberry.com
named-placeholders 1.1.1	MIT	Copyright (c) 2014 Andrey Sidorov
NAN 2.8.0	MIT	
NAN 2.5.1	MIT	Copyright (c) 2015 NAN contributors NAN contributors listed at < https://github.com/nodejs/nan#contributors >
nanomatch 1.2.9	MIT	Copyright (c) 2016-2018 Jon Schlinkert
nanomatch 1.2.7	MIT	
natural 0.2.1	MIT	Copyright (c) 2011, 2012 Chris Umbel, Rob Ellis, Russell Mull
natural-compare-lite 1.4.0	MIT	Copyright (c) 2012-2015 Lauri Rooden <lauri@rooden.ee><lauri@rooden.ee>
ncurses 5.9	MIT-like License (ncurses)	Copyright (c) 1998-2004, 2006 Free Software Foundation, Inc.
needle 1.6.0	MIT	Copyright (c) Fork, Ltd.
negotiator 0.6.1	MIT	Copyright (c) 2012-2014 Federico Romero Copyright (c) 2012-2014 Isaac Z. Schlueter Copyright (c) 2014-2015 Douglas Christopher Wilson
nghttp2 1.7.1	MIT	Copyright (c) 2012, 2014, 2015, 2016 Tatsuhiro Tsujikawa
nib 1.1.2	MIT	Copyright (c) 2014 TJ Holowaychuk <tj@vision-media.ca>
nise 1.3.2	BSD-3-Clause	Copyright (c) 2010-2017, Christian Johansen, christian@cjohansen.no. All rights reserved.
nocache 2.0.0	MIT	Copyright (c) 2014-2016 Evan Hahn, Adam Baldwin
node-amp 0.3.1	MIT	
node-amp-message 0.1.2	MIT	
node-asn1 0.2.3	MIT	Copyright (c) 2011 Mark Cavage
node-assert-plus 1.0.0	MIT	Copyright (c) 2012 Mark Cavage
node-assert-plus 0.2.0	MIT	Copyright (c) 2012 Mark Cavage
node-charm 0.1.2	MIT	Copyright (c) James Halliday <mail@substack.net>
node-clone 1.0.3	MIT	Copyright (c) 2011-2015 Paul Vorbach <paul@vorba.ch>
node-combined-stream 1.0.7	MIT	Copyright (c) 2011 Debuggable Limited <felix@debuggable.com>
node-combined-stream 1.0.6	MIT	Copyright (c) 2011 Debuggable Limited <felix@debuggable.com>
node-combined-stream 1.0.5	MIT	Copyright (c) 2011 Debuggable Limited <felix@debuggable.com>
node-commandir 1.0.1	MIT	Copyright (c) 2013 James Halliday (mail@substack.net)
node-concat-map 0.0.1	MIT	
node-continuation-local-storage 3.2.0	BSD-2-Clause	Copyright (c) 2013-2016 Forrest L Norvell <ogd@aoaioxxysz.net>

Open Source Software Notice (Cont.)

node-cookie-signature 1.0.6	MIT	Copyright (c) 2012 LearnBoost <tj@learnboost.com>
node-crc 3.4.4	MIT	Copyright 2014 Alex Gorbachev
node-cron 1.2.1	ISC	Copyright (c) 2016, Lucas Merencia <lucas.merencia@gmail.com></lucas.merencia@gmail.com>
node-dashdash 1.14.1	MIT	Copyright (c) 2013 Trent Mick Copyright (c) 2013 Joyent Inc.
node-deep-extend 0.4.2	MIT	Copyright (c) 2013-2015 Viacheslav Lotsmanov
node-delayed-stream 1.0.0	MIT	Copyright (c) 2011 Debuggable Limited <felix@debuggable.com>
node-delegates 1.0.0	MIT	Copyright (c) 2015 TJ Holowaychuk <tj@vision-media.ca>
node-diskusage 0.2.4	MIT	Copyright (c) 2016
node-errno 0.1.7	MIT	Copyright (c) 2012-2015 Rod Vagg (@rvagg)
node-errno 0.1.6	MIT	Copyright (c) 2012-2015 Rod Vagg (@rvagg)
node-error-ex 1.3.1	MIT	Copyright (c) 2015 JD Ballard
node-extend 3.0.2	MIT	Copyright (c) 2014 Stefan Thomas
node-extend 3.0.1	MIT	Copyright (c) 2014 Stefan Thomas
node-extend 1.3.0	MIT	Copyright (c) 2014 Stefan Thomas
node-extsprintf 1.3.0	MIT	Copyright (c) 2012 Joyent, Inc.
node-formidable 1.2.1	MIT	Copyright (c) 2011 Felix Geisendörfer
node-fs-extra 2.1.2	MIT	Copyright (c) 2011-2016 JP Richardson
node-getpass 0.1.7	MIT	Copyright (c) Joyent, Inc.
node-glob 7.1.3	ISC	Copyright (c) Isaac Z. Schlueter and contributors
node-glob 7.1.2	ISC	Copyright (c) Isaac Z. Schlueter and contributors
node-glob 7.0.6	ISC	Copyright (c) Isaac Z. Schlueter and contributors
node-glob 5.0.15	ISC	Copyright (c) Isaac Z. Schlueter and contributors
node-graceful-fs 4.1.11	ISC	Copyright (c) Isaac Z. Schlueter ("Author")
node-http-signature 1.2.0	MIT	Copyright (c) Joyent, Inc.
node-http-signature 1.1.1	MIT	Copyright (c) Joyent, Inc.
node-ip 1.1.5	MIT	Copyright (c) 2012 Fedor Indutny
node-is-arrayish 0.2.1	MIT	Copyright (c) 2015 JD Ballard
node-jsonfile 3.0.1	MIT	Copyright (c) 2012-2015 JP Richardson <jprichardson@gmail.com>
node-jsonfile 2.4.0	MIT	Copyright (c) 2012-2015 JP Richardson <jprichardson@gmail.com>
node-jsprim 1.4.1	MIT	Copyright (c) 2012 Joyent, Inc.
node-jwt-simple 0.5.1	MIT	Copyright (c) 2011 Kazuhito Hokamura <k.hokamura@gmail.com>
node-libs-browser 0.7.0	MIT	
node-lru-cache 4.1.1	ISC	Copyright (c) Isaac Z. Schlueter and contributors
node-lru-cache 2.7.3	ISC	Copyright (c) 2009, 2010, 2011 Isaac Z. Schlueter

Open Source Software Notice (Cont.)

node-lru-cache 2.5.0	MIT	Copyright (c) 2009, 2010, 2011 Isaac Z. Schlueter
node-mime 1.4.1	MIT	Copyright (c) 2010 Benjamin Thomas, Robert Kieffer
node-mkdirp 0.5.1	MIT	Copyright (c) 2010 James Halliday (mail@substack.net)
node-multimeter 0.1.2	MIT	Copyright (c) James Halliday <mail@substack.net>
node-mysql2 1.6.1	MIT	Copyright (c) 2016 Andrey Sidorov (sidorares@yandex.ru) and contributors
node-mysql2 1.5.1	MIT	
node-optimist 0.6.1	MIT	Copyright (c) 2010 James Halliday (mail@substack.net)
node-os 0.1.1	MIT	Copyright (c) Diego Rodríguez Baquero <diegorbaquero@gmail.com>
node-os-shim 0.1.3	MIT	Copyright (c) 2013 Adesis Netlife S.L and contributors
node-pre-gyp 0.6.36	BSD-3-Clause	Copyright (c) Mapbox
node-promptly 2.2.0	MIT	Copyright (c) 2012 IndigoUnited
node-properties 1.2.1	MIT	Copyright (c) 2014 Gabriel Llamas
node-rechoir 0.6.2	MIT	Copyright (c) 2015 Tyler Kellen
node-redis-parser 2.6.0	MIT	Copyright (c) 2015 NodeRedis
node-require-directory 2.1.1	MIT	Copyright (c) 2011 Troy Goode <troygoode@gmail.com>
node-semver 5.5.0	ISC	Copyright (c) Isaac Z. Schlueter and contributors
node-semver 5.4.1	ISC	Copyright (c) Isaac Z. Schlueter and contributors
node-source-map-support 0.5.3	MIT	Copyright (c) 2014 Evan Wallace
node-source-map-support 0.4.18	MIT	Copyright (c) 2014 Evan Wallace
node-sshpk 1.13.1	MIT	Copyright (c) Joyent, Inc.
node-stack-trace 0.0.10	MIT	Copyright (c) 2011 Felix Geisendörfer (felix@debuggable.com)
node-tar 2.2.1	ISC	Copyright (c) Isaac Z. Schlueter
node-touch 3.1.0	ISC	Copyright (c) Isaac Z. Schlueter
node-url 0.11.0	MIT	Copyright (c) Joyent, Inc. and other Node contributors
node-uuid 3.2.1	MIT	Copyright (c) 2010-2016 Robert Kieffer and other contributors
node-uuid 3.1.0	MIT	Copyright (c) 2010-2016 Robert Kieffer and other contributors
node-uuid 2.0.3	MIT	Copyright (c) 2010-2016 Robert Kieffer and other contributors
node-verror 1.10.0	MIT	Copyright (c) 2016 Joyent, Inc.
node-which 1.3.0	ISC	Copyright (c) Isaac Z. Schlueter and contributors
node-which 1.2.14	ISC	Copyright (c) Isaac Z. Schlueter and contributors
node-wordwrap 1.0.0	MIT	
node-wordwrap 0.0.3	MIT	
node-wordwrap 0.0.2	MIT	Copyright (c) James Halliday <mail@substack.net>
nodejs 6.9.5	MIT	Copyright (c) Joyent, Inc. and other Node contributors

Open Source Software Notice (Cont.)

nodejs-depd 1.1.2	MIT	Copyright (c) 2014-2017 Douglas Christopher Wilson
nodejs-depd 1.1.1	MIT	Copyright (c) 2014-2017 Douglas Christopher Wilson
nodemon 1.14.12	MIT	Copyright (c) 2014-2017 TJ Holowaychuk <tj@vision-media.ca></tj@vision-media.ca>
node_redis 0.12.1	MIT	Copyright (c) 2016 by NodeRedis
nopt 4.0.1	ISC	Copyright 2009, 2010, 2011 Isaac Z. Schlueter
nopt 3.0.6	ISC	Copyright (c) Isaac Z. Schlueter and contributors
nopt 1.0.10	MIT	Copyright (c) 2009, 2010, 2011 Isaac Z. Schlueter
normalize-package-data 2.4.0	BSD-2-Clause	Copyright (c) Meryn Stol ("Author")
normalize-path 2.1.1	MIT	Copyright (c) 2014-2015 Jon Schlinkert
npm 3.10.10	Artistic-2.0	Copyright (c) npm, Inc. and contributors Copyright (c) 2000-2006 The Perl Foundation
npmlog 4.1.2	ISC	Copyright (c) Isaac Z. Schlueter and contributors
nsocket 0.6.0	MIT	Copyright (c) 2011 Charlie Robbins, Paolo Fragomeni, & the contributors
ntp 4.2.6p5	NTP	Copyright (c) University of Delaware 1992-2011
ntpdate 4.2.6p5	NTP	
number-is-nan 1.0.1	MIT	Copyright (c) Sindre Sorhus <sindresorhus@gmail.com> (sindresorhus.com)
oauth-sign 0.8.2	Apache-2.0	Copyright (c) Mikeal Rogers <mikeal.rogers@gmail.com> (http://www.futurealoof.com)
oauth2orize 1.11.0	MIT	Copyright (c) 2012-2017 Jared Hanson
object-assign 4.1.1	MIT	Copyright (c) 2012-2017 Jared Hanson
object-copy 0.1.0	MIT	Copyright (c) 2016 Jon Schlinkert
object-visit 1.0.1	MIT	Copyright (c) 2015, 2017 Jon Schlinkert
object.omit 2.0.1	MIT	Copyright (c) 2014-2015 Jon Schlinkert
object.pick 1.3.0	MIT	Copyright (c) 2014-2016 Jon Schlinkert
on-finished 2.3.0	MIT	Copyright (c) 2013 Jonathan Ong <me@jongleberry.com> Copyright (c) 2014 Douglas Christopher Wilson <doug@somethingdoug.com>
on-headers 1.0.1	MIT	Copyright (c) 2014 Douglas Christopher Wilson
once 1.4.0	ISC	Copyright (c) Isaac Z. Schlueter and contributors
onetime 1.1.0	MIT	Copyright (c) Sindre Sorhus <sindresorhus@gmail.com> (sindresorhus.com)
OpenEXR 1.7.1	BSD-3-Clause	Copyright (c) 2002-2011 Industrial Light & Magic, a division of Lucasfilm Entertainment Company Ltd.
openlayers 5.3.0	BSD-2-Clause	
openldap 2.4.40	OLDAP-2.8	Copyright (c) 1998-2014 The OpenLDAP Foundation

Open Source Software Notice (Cont.)

openssh 6.6.1p1	OpenSSH License	
openssl 1.0.1e	OpenSSL	Copyright (c) 2015 OpenSSL Software Foundation
os-homedir 1.0.2	MIT	Copyright (c) Sindre Sorhus <sindresorhus@gmail.com> (sindresorhus.com)
os-locale 1.4.0	MIT	Copyright (c) Sindre Sorhus <sindresorhus@gmail.com> (sindresorhus.com)
os-tmpdir 1.0.2	MIT	Copyright (c) Sindre Sorhus <sindresorhus@gmail.com> (sindresorhus.com)
osenv 0.1.4	ISC	Copyright (c) Isaac Z. Schlueter and contributors
p-finally 1.0.0	MIT	Copyright (c) Sindre Sorhus <sindresorhus@gmail.com> (sindresorhus.com)
p-limit 1.3.0	MIT	Copyright (c) Sindre Sorhus <sindresorhus@gmail.com> (sindresorhus.com)
p-locate 2.0.0	MIT	Copyright (c) Sindre Sorhus <sindresorhus@gmail.com> (sindresorhus.com)
p-map 1.2.0	MIT	Copyright (c) Sindre Sorhus <sindresorhus@gmail.com> (sindresorhus.com)</sindresorhus@gmail.com>
p-try 1.0.0	MIT	Copyright (c) Sindre Sorhus <sindresorhus@gmail.com> (sindresorhus.com)
p11-kit 0.20.7	BSD-3-Clause	Copyright (c) 2011 Collabora Ltd.
package-json 4.0.1	MIT	Copyright (c) Sindre Sorhus <sindresorhus@gmail.com> (sindresorhus.com)</sindresorhus@gmail.com>
pako 0.2.9	MIT	Copyright (C) 2014-2015 by Vitaly Puzrin
parallel-transform 1.1.0	MIT	Copyright 2013 Mathias Buus
parse-glob 3.0.4	MIT	Copyright (c) 2015 Jon Schlinkert
parse-json 2.2.0	MIT	Copyright (c) Sindre Sorhus <sindresorhus@gmail.com> (sindresorhus.com)
parseurl 1.3.2	MIT	Copyright (c) 2014 Jonathan Ong <me@jongleberry.com> Copyright (c) 2014-2017 Douglas Christopher Wilson <doug@somethingdoug.com>
passport 0.3.2	MIT	Copyright (c) 2011-2015 Jared Hanson
passport-http 0.3.0	MIT	Copyright (c) 2011-2013 Jared Hanson
passport-http-bearer 1.0.1	MIT	Copyright (c) 2011-2013 Jared Hanson
passport-oauth2-client-password 0.1.2	MIT	Copyright (c) 2012-2013 Jared Hanson
passport-strategy 1.0.0	MIT	Copyright (c) 2011-2014 Jared Hanson
passwd 0.79	BSD-3-Clause	Copyright (c) 1998, 1999, 2001, 2002 Red Hat, Inc.
path-browserify 0.0.0		
path-dirname 1.0.2		Copyright (c) Elan Shanker and Node.js contributors

Open Source Software Notice (Cont.)

path-exists 2.1.0	MIT	Copyright (c) Sindre Sorhus <sindresorhus@gmail.com> (sindresorhus.com)
path-is-absolute 1.0.1	MIT	Copyright (c) Sindre Sorhus <sindresorhus@gmail.com> (sindresorhus.com)
path-is-inside 1.0.2	MIT	Copyright (c) 2013–2016 Domenic Denicola <d@domenic.me>
path-key 2.0.1	MIT	Copyright (c) Sindre Sorhus <sindresorhus@gmail.com> (sindresorhus.com)
path-parse 1.0.5	MIT	Copyright (c) Javier Blanco
path-to-regexp 1.7.0	MIT	Copyright (c) 2014 Blake Embrey (hello@blakeembrey.com)
path-to-regexp 0.1.7	MIT	Copyright (c) 2014 Blake Embrey (hello@blakeembrey.com)
path-type 3.0.0	MIT	Copyright (c) Sindre Sorhus <sindresorhus@gmail.com> (sindresorhus.com)
path-type 1.1.0	MIT	Copyright (c) Sindre Sorhus <sindresorhus@gmail.com> (sindresorhus.com)
pathval 1.1.0	MIT	Copyright (c) 2011-2013 Jake Luer jake@alogicalparadox.com
pause 0.0.1	MIT	Copyright (c) 2012 TJ Holowaychuk <tj@vision-media.ca>
pause-stream 0.0.11	MIT	Copyright (c) 2013 Dominic Tarr
pbkdf2-compat 2.0.1	MIT	Copyright (c) 2014 Daniel Cousens
pcrc 8.32	BSD-3-Clause	Copyright (c) University of Cambridge Computing Service, Cambridge, England Copyright (c) 1997-2012 University of Cambridge Copyright (c) 2009-2012 Zoltan Herczeg Copyright (c) 2007-2012 Google Inc.
pcsc-lite 1.8.8	BSD-3-Clause	Copyright (c) 1999-2003 David Corcoran <corcoran@musclecard.com> Copyright (c) 2001-2011 Ludovic Rousseau <ludovic.rousseau@free.fr>
performance-now 2.1.0	MIT	Copyright (c) 2013 Braveg1rl
performance-now 0.2.0	MIT	Copyright (c) 2013 Braveg1rl
perl 5.16.3	Artistic-1.0-Perl	Copyright (c) 1993-2017 by Larry Wall and others
perl-Carp 1.26	Artistic-1.0-Perl	
perl-Compress-Raw-Bzip2 2.061	Artistic-1.0-Perl	
perl-Compress-Raw-Zlib 2.061	Artistic-1.0-Perl	
perl-constant 1.27	Artistic-1.0-Perl	
perl-Data-Dumper 2.145	Artistic-1.0-Perl	
perl-DBD-MySQL 4.023	Artistic-1.0-Perl	
perl-DBI 1.627	Artistic-1.0-Perl	
perl-Encode 2.51	Artistic-1.0-Perl	
perl-Exporter 5.68	Artistic-1.0-Perl	

Open Source Software Notice (Cont.)

perl-File-Path 2.09	Artistic-1.0-Perl	
perl-File-Temp 0.23.01	Artistic-1.0-Perl	
perl-Filter 1.49	Artistic-1.0-Perl	
perl-Getopt-Long 2.4	Artistic-1.0-Perl	
perl-HTTP-Tiny 0.033	Artistic-1.0-Perl	
perl-IO-Compress 2.061	Artistic-1.0-Perl	
perl-Net-Daemon 0.48	Artistic-1.0-Perl	
perl-parent 0.225	Artistic-1.0-Perl	
perl-PathTools 3.4	Artistic-1.0-Perl	
perl-PIRPC 0.202	Artistic-1.0-Perl	
perl-Pod-Escapes 1.04	Artistic-1.0-Perl	
perl-Pod-Perldoc 3.2	Artistic-1.0-Perl	
perl-Pod-Simple 3.28	Artistic-1.0-Perl	
perl-Pod-Usage 1.63	Artistic-1.0-Perl	
perl-podlators 2.5.1	Artistic-1.0-Perl	
perl-Scalar-List-Utils 1.27	Artistic-1.0-Perl	
perl-Socket 2.01	Artistic-1.0-Perl	
perl-Storable 2.45	Artistic-1.0-Perl	
perl-Text-ParseWords 3.29	Artistic-1.0-Perl	
perl-threads 1.87	Artistic-1.0-Perl	
perl-threads-shared 1.43	Artistic-1.0-Perl	
perl-Time-HiRes 1.9725	Artistic-1.0-Perl	
perl-Time-Local 1.23	Artistic-1.0-Perl	
php56u 5.6.21	PHP-3.01	
php56u-cli 5.6.21	PHP-3.01	
php56u-common 5.6.21	PHP-3.01	
php56u-fpm 5.6.21	PHP-3.01	
php56u-gd 5.6.21	PHP-3.01	
php56u-intl 5.6.21	PHP-3.0	
php56u-mysqlnd 5.6.21	PHP-3.0	
php56u-pdo 5.6.21	PHP-3.0	
php56u-pecl-jsonc 1.3.9	PHP-3.0	
php56u-process 5.6.21	PHP-3.0	
php56u-xml 5.6.21	PHP-3.0	
pidusage 1.2.0	MIT	Copyright (c) 2014 soyuka

Open Source Software Notice (Cont.)

pify 3.0.0	MIT	Copyright (c) Sindre Sorhus <sindresorhus@gmail.com> (sindresorhus.com)
pify 2.3.0	MIT	Copyright (c) Sindre Sorhus <sindresorhus@gmail.com> (sindresorhus.com)
pinkie 2.0.4	MIT	Copyright (c) Vsevolod Strukchinsky <floatdrop@gmail.com> (github.com/floatdrop)
pinkie-promise 2.0.1	MIT	Copyright (c) Vsevolod Strukchinsky <floatdrop@gmail.com> (github.com/floatdrop)
Pixman 0.32.6	MIT	Copyright (c) 2012 Hannes Flicka
pkg-dir 2.0.0	MIT	Copyright (c) Sindre Sorhus <sindresorhus@gmail.com> (sindresorhus.com)
pkg-dir 1.0.0	MIT	Copyright (c) Sindre Sorhus <sindresorhus@gmail.com> (sindresorhus.com)</sindresorhus@gmail.com>
platform.js 1.3.5	MIT	Copyright 2014-2018 Benjamin Tan <https://demoneaux.github.io=""> Copyright 2011-2013 John-David Dalton <http://allyoucanleet.com=""></http:></https:>
pluralize 1.2.1	MIT	Copyright (c) 2013 Blake Embrey (hello@blakeembrey.com)
pm2-axon-rpc 0.5.0	MIT	Copyright (c) Bret Copeland <bret@atlantisflight.org>
pm2-deploy 0.3.9	MIT	Copyright (c) 2010-2015 Alexandre Strzelewicz
pmx 1.5.6	MIT	Copyright (c) Keymetrics I/O
Polyfill for Object.setPrototypeOf 1.1.0	ISC	Copyright (c) 2015 Wes Todd
Polyfill for Object.setPrototypeOf 1.0.3	ISC	Copyright (c) 2015 Wes Todd
poppler-data 0.4.6	MIT	
popt 1.13	X11	Copyright (c) 1998 Red Hat Software
posix-character-classes 0.1.1	MIT	Copyright (c) 2016-2017 Jon Schlinkert
pre-commit 1.2.2	MIT	Copyright (c) 2015 Arnout Kazemier, Martijn Swaagman, the contributors
prelude-ls 1.1.2	MIT	Copyright (c) George Zahariev
prepend-http 1.0.4	MIT	Copyright (c) Sindre Sorhus <sindresorhus@gmail.com> (sindresorhus.com)</sindresorhus@gmail.com>
preserve 0.2.0	MIT	Copyright (c) 2014-2015 Jon Schlinkert
private 0.1.8	MIT	Copyright (c) 2014 Ben Newman <bn@cs.stanford.edu>
process 0.11.10	MIT	
process-nextick-args 2.0.0	MIT	Copyright (c) 2015 Calvin Metcalf
process-nextick-args 1.0.7	MIT	
progress 1.1.8	MIT	Copyright (c) 2014 TJ Holowaychuk <tj@vision-media.ca>
promise 7.3.1	MIT	Copyright (c) 2014 Forbes Lindesay

Open Source Software Notice (Cont.)

promise-core 1.1.1	ISC	Copyright (c) 2016 Nicolai Kamenzky and contributors
promise-inflight 1.0.1	ISC	Copyright (c) 2017, Rebecca Turner <me@re-becca.org></me@re-becca.org>
promise-while 1.0.1	ISC	
proxy-addr 2.0.2	MIT	Copyright (c) 2014-2016 Douglas Christopher Wilson
proxyquire 1.8.0	MIT	Copyright (c) 2013 Thorsten Lorenz
prr 1.0.1	MIT	Copyright 2013, Rod Vagg (the "Original Author")
ps-tree 1.1.0	MIT	Copyright (c) 2014 Domenic Tarr, Charlie Robbins & the contributors
pseudomap 1.0.2	ISC	Copyright (c) Isaac Z. Schlueter and contributors
pstree.remy 1.1.0	MIT	
pug 2.0.0-rc.4	MIT	
pug-attrs 2.0.2	MIT	Copyright (c) 2015 Forbes Lindesay
pug-code-gen 2.0.0	MIT	Copyright (c) 2015 Forbes Lindesay
pug-error 1.3.2	MIT	Copyright (c) 2015 Forbes Lindesay
pug-filters 2.1.5	MIT	Copyright (c) 2015 Forbes Lindesay
pug-lexer 3.1.0	MIT	Copyright (c) 2015 Forbes Lindesay
pug-linker 3.0.3	MIT	Copyright (c) 2015 Forbes Lindesay
pug-load 2.0.9	MIT	Copyright (c) 2015 Forbes Lindesay
pug-parser 4.0.0	MIT	Copyright (c) 2014 Forbes Lindesay
pug-runtime 2.0.3	MIT	Copyright (c) 2014 Forbes Lindesay
pug-strip-comments 1.0.2	MIT	Copyright (c) 2015 Tiancheng "Timothy" Gu
pug-walk 1.1.5	MIT	Copyright (c) 2015 Forbes Lindesay
pump 2.0.1	MIT	Copyright (c) 2014 Mathias Buus
pumpify 1.5.1	MIT	Copyright (c) 2014 Mathias Buus
Punycode.js 2.1.1	MIT	
Punycode.js 2.1.0	MIT	
Punycode.js 1.4.1	MIT	Copyright (c) Mathias Bynens <http://mathiasbynens.be/>
Punycode.js 1.3.2	MIT	Copyright (c) Mathias Bynens <http://mathiasbynens.be/>
python 2.7.5	Python-2.0	
python-argparse 1.0.9	Python-2.0	Copyright (c) 2006-2009 Steven J. Bethard <steven.bethard@gmail.com>
python-configobj 4.7.2	BSD-3-Clause	
python-decorator 3.4.0	BSD-3-Clause	
python-iniparse 0.4	MIT	
python-lpy 0.75	BSD-3-Clause	Copyright (c) 2006, INL Copyright (c) 2001-2005, Maximillian Dornseif

Open Source Software Notice (Cont.)

python-libs 2.7.5	Python-2.0	
python-lxml 3.2.1	BSD-3-Clause	
qs 6.5.2	BSD-3-Clause	Copyright (c) TJ Holowaychuk <tj@vision-media.ca> (http://tjholowaychuk.com)
qs 6.5.1	BSD-3-Clause	Copyright (c) 2014 Nathan LaFreniere and other contributors
qs 6.4.0	BSD-3-Clause	Copyright (c) 2014 Nathan LaFreniere and other contributors
querystring 0.2.1	MIT	Copyright (c) 2012 Irakli Gozalishvili
querystring 0.2.0	MIT	Copyright (c) 2012 Irakli Gozalishvili
quota 4.01	BSD-4-Clause	Copyright (c) 1980, 1990 Regents of the University of California Copyright (c) 2000, 2001 Silicon Graphics, Inc. [SGI]
random-bytes 1.0.0	MIT	Copyright (c) 2016 Douglas Christopher Wilson <doug@somethingdoug.com>
random-js 1.0.8	MIT	Copyright (c) 2014 Cameron Knight (ckknight@gmail.com)
randomatic 1.1.7	MIT	Copyright (c) 2013-2015 Jon Schlinkert
range-parser 1.2.0	MIT	Copyright (c) 2012-2014 TJ Holowaychuk <vision-media.ca>
raw-body 2.3.2	MIT	Copyright (c) 2013-2014 Jonathan Ong <me@jongleberry.com> Copyright (c) 2014-2015 Douglas Christopher Wilson <doug@somethingdoug.com>
rc 1.2.5	Apache-2.0	Copyright (c) Dominic Tarr <dominic.tarr@gmail.com>
rc 1.2.2	Apache-2.0	Copyright (c) Dominic Tarr <dominic.tarr@gmail.com>
read 1.0.7	ISC	Copyright (c) Isaac Z. Schlueter and contributors
read-pkg 1.1.0	MIT	Copyright (c) Sindre Sorhus <sindresorhus@gmail.com> (sindresorhus.com)
read-pkg-up 1.0.1	MIT	Copyright (c) Sindre Sorhus <sindresorhus@gmail.com> (sindresorhus.com)
readable-stream 2.3.3	MIT	Copyright (c) Joyent, Inc. and other Node contributors Copyright (c) Node.js contributors
readable-stream 2.3.2	MIT	Copyright (c) Joyent, Inc. and other Node contributors Copyright (c) Node.js contributors
readdirp 2.1.0	MIT	Copyright (c) 2012-2015 Thorsten Lorenz
readline2 1.0.1	MIT	Copyright (c) 2014 Simon Boudrias
redeyed 2.1.1	MIT	Copyright (c) 2012 Thorsten Lorenz
redeyed 1.0.1	MIT	Copyright (c) 2012 Thorsten Lorenz
redis 3.2.3	BSD-3-Clause	Copyright (c) 2006-2015 Salvatore Sanfilippo
redis 2.8.0	BSD-3-Clause	Copyright (c) 2009-2012 Salvatore Sanfilippo
redis 2.6.5	BSD-3-Clause	Copyright (c) 2006-2015 Salvatore Sanfilippo
redis-commands 1.3.1	MIT	Copyright (c) 2015 NodeRedis

Open Source Software Notice (Cont.)

reds 0.2.5	MIT	Copyright (c) TJ Holowaychuk <tj@vision-media.ca>
referrer-policy 1.1.0	MIT	Copyright (c) 2016 Evan Hahn
regenerate 1.3.3	MIT	Copyright Mathias Bynens <https://mathiasbynens.be/>
regenerator 0.10.1	BSD-2-Clause	Copyright (c) 2014, Facebook, Inc.
regenerator-runtime 0.11.1	MIT	Copyright (c) 2014-present, Facebook, Inc.
regex-cache 0.4.4	MIT	Copyright (c) 2015-2016 Jon Schlinkert
regex-not 1.0.0	MIT	Copyright (c) 2016, 2018 Jon Schlinkert
regexpu-core 2.0.0	MIT	Copyright (c) Mathias Bynens
registry-auth-token 3.3.2	MIT	Copyright (c) 2016 Espen Hovlandsdal
registry-url 3.1.0	MIT	Copyright (c) Sindre Sorhus <sindresorhus@gmail.com> (sindresorhus.com)
regjsgen 0.2.0	MIT	Copyright (c) 2014 Benjamin Tan <demoneaux@gmail.com> (https://d10.github.io/)
regjsparser 0.1.5	BSD-2-Clause	Copyright (c) Julian Viereck and contributors
remove-trailing-separator 1.1.0	ISC	Copyright (c) darsain
repeat-element 1.1.2	MIT	Copyright (c) 2015 Jon Schlinkert
repeat-string 1.6.1	MIT	Copyright (c) 2014-2015 Jon Schlinkert
repeating 2.0.1	MIT	Copyright (c) Sindre Sorhus <sindresorhus@gmail.com> (sindresorhus.com)
request 2.83.0	Apache-2.0	Copyright (c) Mikeal Rogers <mikeal.rogers@gmail.com>
request 2.81.0	Apache-2.0	
request-promise 4.2.2	ISC	Copyright (c) 2017 Nicolai Kamenzky, Ty Abonil, and contributors
require-main-filename 1.0.1	ISC	Copyright (c) 2016 Contributors
require-package-name 2.0.1	MIT	Copyright (c) 2015 Matt DesLauriers
resolve 1.5.0	MIT	
resolve 1.1.7	MIT	
resolve-from 1.0.1	MIT	Copyright (c) Sindre Sorhus <sindresorhus@gmail.com> (sindresorhus.com)
resolve-url 0.2.1	MIT	Copyright (c) 2013 Simon Lydell
restore-cursor 1.0.1	MIT	Copyright (c) Sindre Sorhus <sindresorhus@gmail.com> (sindresorhus.com)
rfskill 0.4	ISC	
right-align 0.1.3	MIT	Copyright (c) 2015 Jon Schlinkert
rimraf 2.6.2	ISC	Copyright (c) Isaac Z. Schlueter and contributors
ripemd160 0.2.0	MIT	Copyright (c) 2016 crypto-browserify
run-async 0.1.0	MIT	Copyright (c) 2014 Simon Boudrias
run-queue 1.0.3	ISC	Copyright (c) Rebecca Turner
RxJS 5.5.0	Apache-2.0	Copyright (c) Microsoft Open Technologies, Inc

Open Source Software Notice (Cont.)

safe-buffer 5.1.2	MIT	Copyright (c) Feross Aboukhadijeh
safe-buffer 5.1.1	MIT	Copyright (c) Feross Aboukhadijeh
samsam 1.3.0	BSD-3-Clause	Copyright (c) 2010-2012, Christian Johansen, christian@cjohansen.no and August Lilleaas, august.lilleaas@gmail.com
sax-js 0.5.8	BSD-2-Clause MIT W3C	Copyright (c) Isaac Z. Schlueter ("Author") Copyright (c) Isaac Z. Schlueter ("Author") Copyright Mathias Bynens <http: mathiasbynens.be="">
schema-utils 0.4.7	MIT	Copyright (c) JS Foundation and other contributors
scripty 0.0.5	MIT	Copyright (c) 2014 Geoff Wagstaff
semver-diff 2.1.0	MIT	Copyright (c) Sindre Sorhus <sindresorhus@gmail.com> (sindresorhus.com)</sindresorhus@gmail.com>
send 0.16.1	MIT	Copyright (c) 2012 TJ Holowaychuk Copyright (c) 2014-2016 Douglas Christopher Wilson
seq-queue 0.0.5	MIT	Copyright (c) 2012 Netease, Inc. and other pomelo contributors
serialize-javascript 1.5.0		BSD-3-Clause
serve-static 1.13.1	MIT	Copyright (c) 2010 Sencha Inc. Copyright (c) 2011 LearnBoost Copyright (c) 2011 TJ Holowaychuk Copyright (c) 2014 Douglas Christopher Wilson
set-blocking 2.0.0	ISC	Copyright (c) 2016 Contributors
set-getter 0.1.0	MIT	Copyright (c) 2016 Brian Woodward
set-immediate-shim 1.0.1	MIT	Copyright (c) Sindre Sorhus <sindresorhus@gmail.com> (sindresorhus.com)
set-value 2.0.0	MIT	Copyright (c) 2014-2017 Jon Schlinkert
set-value 0.4.3	MIT	Copyright (c) 2014-2017 Jon Schlinkert
setImmediate 1.0.5	MIT	Copyright (c) 2012 Barnesandnoble.com, llc, Donavon West, and Domenic Denicola
sg3-utils 1.37	BSD-3-Clause	Copyright (c) 1994-2012 Douglas Gilbert <dgilbert at interlog dot com> Copyright (c) 1994-2012 Bruce Allen <ballen at gravity dot phys dot uwm dot edu> Copyright (c) 1994-2012 Peter Allworth <linsol at zeta dot org dot au> Copyright (c) 1994-2012 James Bottomley <jejb at parisc-linux dot org> Copyright (c) 1994-2012 Lars Marowsky-Bree <lmb at suse dot de> Copyright (c) 1994-2012 Kurt Garloff <garloff at suse dot de> Copyright (c) 1994-2012 Grant Grundler <grundler at parisc-linux dot org> Copyright (c) 1994-2012 Christophe Varoqui <christophe dot varoqui at free dot fr> Copyright (c) 1994-2012 Michael Weller <eowmob at exp-math dot uni-essen dot de> Copyright (c) 1994-2012 Eric Youngdale <eric at andante dot org>
sha.js 2.2.6	BSD-3-Clause MIT	Copyright (c) 1998 - 2009, Paul Johnston & contributors Copyright (c) 2013-2018 sha.js contributors

Open Source Software Notice (Cont.)

shebang-command 1.2.0	MIT	Copyright (c) Kevin Martensson <kevinmartensson@gmail.com> (github.com/kevva)
shebang-regex 1.0.0	MIT	Copyright (c) Sindre Sorhus <sindresorhus@gmail.com> (sindresorhus.com)
shelljs 0.8.1	BSD-3-Clause	Copyright (c) 2012, Artur Adib <aadib@mozilla.com> </aadib@mozilla.com>
shelljs 0.7.8	BSD-3-Clause	Copyright (c) 2012 Artur Adib <aadib@mozilla.com>
shimmer 1.1.0	BSD-2-Clause	
signal-exit 3.0.2	ISC	Copyright (c) 2015 Contributors
simple-oauth2 1.5.0	Apache-2.0	Copyright (c) Andrea Reginato <andrea.reginato@gmail.com>
sinon 4.5.0	BSD-3-Clause	Copyright (c) 2010-2017 Christian Johansen, christian@cjohansen.no
six 1.9.0	MIT	Copyright (c) 2010-2015 Benjamin Peterson
slash 1.0.0	MIT	Copyright (c) Sindre Sorhus <sindresorhus@gmail.com> (sindresorhus.com)
slice-ansi 0.0.4	MIT	Copyright (c) David Caccavella
snapdragon 0.8.1	MIT	Copyright (c) 2015-2016 Jon Schlinkert
snapdragon-node 2.1.1	MIT	Copyright (c) 2017 Jon Schlinkert
snapdragon-util 3.0.1	MIT	Copyright (c) 2017 Jon Schlinkert
snappy 1.1.0	BSD-3-Clause	Copyright 2011 Google Inc.
sntp 2.1.0	BSD-3-Clause	Copyright (c) 2012-2013 Eran Hammer
sntp 1.0.9	BSD-3-Clause	Copyright (c) 2012-2013 Eran Hammer
source-list-map 2.0.0	MIT	Copyright (c) 2017 JS Foundation
source-list-map 0.1.8	MIT	Copyright (c) 2017 JS Foundation
source-map 0.5.7	BSD-3-Clause	Copyright (c) 2009-2011 Mozilla Foundation and contributors
source-map 0.4.4	BSD-3-Clause	Copyright (c) 2009-2011 Mozilla Foundation and contributors
source-map 0.2.0	BSD-3-Clause	Copyright (c) 2009-2011 Mozilla Foundation and contributors
source-map 0.1.43	BSD-3-Clause	Copyright (c) 2009-2011 Mozilla Foundation and contributors
source-map-resolve 0.5.1	MIT	Copyright (c) 2014, 2015, 2016, 2017 Simon Lydell
source-map-url 0.4.0	MIT	Copyright (c) 2014 Simon Lydell
spawn-sync 1.0.15	MIT	Copyright (c) 2014 Forbes Lindesay
spdx-correct 1.0.2	Apache-2.0	Copyright (c) Kyle E. Mitchell <kyle@kemitchell.com> (https://kemitchell.com)
spdx-expression-parse.js 1.0.4	MIT	Copyright (c) 2015 Kyle E. Mitchell & other authors listed in AUTHORS
spec-xunit-file 0.0.1-3	MIT	Copyright (c) 2014 Joe Cyboski
split 0.3.3	MIT	Copyright (c) 2011 Dominic Tarr
split-camelcase 1.0.1	MIT	

Open Source Software Notice (Cont.)

split-string 3.1.0	MIT	Copyright (c) 2015-2017 Jon Schlinkert
sprintf-js 1.1.1	BSD-3-Clause	Copyright (c) 2007-present Alexandru Mărășteanu <hello@alexei.ro>
sprintf-js 1.0.3	BSD-3-Clause	Copyright (c) 2007-present Alexandru Mărășteanu <hello@alexei.ro>
sql-formatter 2.3.1	MIT	Copyright (c) 2016-present ZeroTurnaround LLC
sqlstring 2.3.1	MIT	Copyright (c) 2012 Felix Geisendörfer (felix@debuggable.com) and contributors
sqlstring 2.3.0	MIT	Copyright (c) 2012 Felix Geisendörfer (felix@debuggable.com) and contributors
ssri 5.3.0	ISC	Copyright (c) npm, Inc.
static-extend 0.1.2	MIT	Copyright (c) 2016 Jon Schlinkert
statuses 1.4.0	MIT	Copyright (c) 2014 Jonathan Ong me@jongleberry.com Copyright (c) 2016 Douglas Christopher Wilson doug@something-doug.com
statuses 1.3.1	MIT	Copyright (c) 2014 Jonathan Ong me@jongleberry.com Copyright (c) 2016 Douglas Christopher Wilson doug@something-doug.com
stealthy-require 1.1.1	ISC	Copyright (c) 2017 Nicolai Kamenzky and contributors
strace 4.8	BSD-3-Clause	Copyright (c) 1991, 1992 Paul Kranenburg <pk@cs.few.eur.nl> Copyright (c) 1993 Branko Lankester <branko@hacktic.nl> Copyright (c) 1993 Ulrich Pegelow <pegelow@moorea.uni-muenster.de> Copyright (c) 1995, 1996 Michael Elizabeth Chastain <mec@duracef.shout.net> Copyright (c) 1993, 1994, 1995, 1996 Rick Sladkey <jrs@world.std.com>
stream-browserify 2.0.1	MIT	Copyright (c) James Halliday
stream-combiner 0.0.4	MIT	Copyright (c) 2012 Dominic Tarr
stream-each 1.2.3	MIT	Copyright (c) 2015 Mathias Buus
stream-http 2.8.0	MIT	Copyright (c) 2015 John Hiesey
stream-shift 1.0.0	MIT	Copyright (c) 2016 Mathias Buus
string-width 2.1.1	MIT	Copyright (c) Sindre Sorhus <sindresorhus@gmail.com> (sindresorhus.com)
string-width 1.0.2	MIT	Copyright (c) Sindre Sorhus <sindresorhus@gmail.com> (sindresorhus.com)
stringstream 0.0.5	MIT	Copyright (c) 2012 Michael Hart (michael.hart.au@gmail.com)
string_decoder 1.1.1	MIT	Copyright (c) Node.js contributors Copyright (c) Joyent, Inc. and other Node contributors
string_decoder 1.0.3	MIT	Copyright (c) Node.js contributors Copyright (c) Joyent, Inc. and other Node contributors

Open Source Software Notice (Cont.)

string_decoder 0.10.31	MIT	Copyright (c) Node.js contributors Copyright (c) Joyent, Inc. and other Node contributors
strip-ansi 4.0.0	MIT	Copyright (c) Sindre Sorhus <sindresorhus@gmail.com> (sindresorhus.com)
strip-ansi 3.0.1	MIT	Copyright (c) Sindre Sorhus <sindresorhus@gmail.com> (sindresorhus.com)
strip-bom 3.0.0	MIT	Copyright (c) Sindre Sorhus <sindresorhus@gmail.com> (sindresorhus.com)
strip-bom 2.0.0	MIT	Copyright (c) Sindre Sorhus <sindresorhus@gmail.com> (sindresorhus.com)
strip-eof 1.0.0	MIT	Copyright (c) Sindre Sorhus <sindresorhus@gmail.com> (sindresorhus.com)
strip-json-comments 2.0.1	MIT	Copyright (c) Sindre Sorhus <sindresorhus@gmail.com> (sindresorhus.com)
stylus 0.54.5	MIT	Copyright (c) Automattic <developer.wordpress.com>
sudo 1.8.6p7	MIT-like License (sudo)	
superagent 3.8.3	MIT	Copyright (c) 2014-2016 TJ Holowaychuk <tj@vision-media.ca>
supports-color 5.4.0	MIT	Copyright (c) Sindre Sorhus <sindresorhus@gmail.com> (sindresorhus.com)
supports-color 5.3.0	MIT	Copyright (c) Sindre Sorhus <sindresorhus@gmail.com> (sindresorhus.com)
supports-color 4.5.0	MIT	Copyright (c) Sindre Sorhus <sindresorhus@gmail.com> (sindresorhus.com)
supports-color 3.2.3	MIT	Copyright (c) Sindre Sorhus <sindresorhus@gmail.com> (sindresorhus.com)
supports-color 2.0.0	MIT	Copyright (c) Sindre Sorhus <sindresorhus@gmail.com> (sindresorhus.com)
sylvester 0.0.21	MIT	Copyright (c) 2011 Chris Umbel, James Cogan
table 3.8.3	BSD-3-Clause	Copyright (c) 2016 Gajus Kuizinas (http://gajus.com/)
tapable 0.1.10	MIT	Copyright (c) Tobias Koppers @sokra
tar-pack 3.4.1	BSD-2-Clause	Copyright (c) 2014 Forbes Lindesay
tcp-wrappers 7.6	BSD-like License (tcp-wrappers)	Copyright 1995 by Wietse Venema. Some individual files may be covered by other copyrights.
tcpdump 4.5.1	BSD-3-Clause	Copyright (c) 2005 The Tcpdump Group
tcsh 6.18.01	BSD-3-Clause	Copyright (c) 1980, 1991 The Regents of the University of California
term-size 1.2.0	MIT	Copyright (c) Sindre Sorhus <sindresorhus@gmail.com> (sindresorhus.com)
text-table 0.2.0	MIT	

Open Source Software Notice (Cont.)

thenify 3.3.0	MIT	Copyright (c) 2014-2016 Jonathan Ong me@jongleberry.com and contributors
thenify-all 1.6.0	MIT	Copyright (c) 2014 Jonathan Ong me@jongleberry.com
through 2.3.8	MIT	Copyright (c) 2011 Dominic Tarr
through2 2.0.3	MIT	Copyright (c) 2016 Rod Vagg (the "Original Author") and additional contributors
tiff 4.0.3	libtiff	Copyright (c) 1988-1997 Sam Leffler Copyright (c) 1991-1997 Silicon Graphics, Inc.
timed-out 4.0.1	MIT	Copyright (c) Vsevolod Strukchinsky <floatdrop@gmail.com></floatdrop@gmail.com>
timers-browserify 2.0.6	MIT	Copyright (c) 2012 J. Ryan Stinnett <jryans@gmail.com></jryans@gmail.com>
to-arraybuffer 1.0.1	MIT	Copyright (c) 2016 John Hiesey
to-fast-properties 2.0.0	MIT	
to-fast-properties 1.0.3	MIT	Copyright (c) 2014 Petka Antonov Copyright (c) 2015 Sindre Sorhus
to-object-path 0.3.0	MIT	Copyright (c) 2015-2016 Jon Schlinkert
to-regex 3.0.1	MIT	Copyright (c) 2016-2018 Jon Schlinkert
to-regex-range 2.1.1	MIT	Copyright (c) 2015-2017 Jon Schlinkert
token-stream 0.0.1	MIT	Copyright (c) 2014 Forbes Lindesay
topo 2.0.2	BSD-3-Clause	Copyright (c) 2012-2016 Project contributors Copyright (c) 2012-2014 Walmart
tough-cookie 2.3.3	BSD-3-Clause	Copyright (c) 2015 Salesforce.com, Inc.
trassingue 1.2.2	Apache-2.0	Copyright (c) Google Inc.
trim-right 1.0.1	MIT	Copyright (c) Sindre Sorhus <sindresorhus@gmail.com> (sindresorhus.com)
triple-beam 1.3.0	MIT	Copyright (c) 2017 winstonjs
trousers 0.3.13	BSD-3-Clause	Copyright (c) 2013 TrouSerS Project
tty-browserify 0.0.0	MIT	
tunnel-agent 0.6.0	Apache-2.0	Copyright (c) Mikeal Rogers <mikeal.rogers@gmail.com> (http://www.futurealooof.com)
type-check 0.3.2	MIT	Copyright (c) George Zahariev
type-detect 4.0.8	MIT	Copyright (c) 2013 Jake Luer <jake@alogicalparadox.com> (http://alogicalparadox.com)</jake@alogicalparadox.com>
type-is 1.6.15	MIT	Copyright (c) 2014 Jonathan Ong <me@jongleberry.com> Copyright (c) 2014-2015 Douglas Christopher Wilson <doug@somethingdoug.com>
typedarray 0.0.6	MIT	Copyright (c) 2010 Linden Research, Inc. Copyright (c) 2012 Joshua Bell
uglify-to-browserify 1.0.2	MIT	Copyright (c) 2013 Forbes Lindesay

Open Source Software Notice (Cont.)

UglifyJS 2.8.29	BSD-2-Clause	Copyright 2012-2013 (c) Mihai Bazon <mihai.bazon@gmail.com>
UglifyJS 2.7.5	BSD-2-Clause	
uglifyjs-webpack-plugin 1.3.0	MIT	Copyright (c) JS Foundation and other contributors
UglifyJS2.git 3.3.9	BSD-2-Clause	Copyright 2012-2018 (c) Mihai Bazon <mihai.bazon@gmail.com>
uid-number 0.0.6	ISC	Copyright (c) Isaac Z. Schlueter
uid-safe 2.1.5	MIT	Copyright (c) 2014 Jonathan Ong me@jongleberry.com
uid2 0.0.3	MIT	
undefsafe 2.0.1	MIT	Copyright (c) 2016 Remy Sharp, http://remysharp.com <remy@remysharp.com></remy@remysharp.com>
Underscore.js 1.8.3	MIT	Copyright (c) 2009-2013 Jeremy Ashkenas, DocumentCloud and Investigative Reporters & Editors
union-value 1.0.0	MIT	Copyright (c) 2015-2017 Jon Schlinkert
uniqider 2.0.1	BSD-3-Clause	Copyright (c) 2015, Boris Ćeranić
unique-filename 1.1.1	ISC	Copyright (c) npm, Inc
unique-slug 2.0.1	ISC	Copyright (c) npm, Inc
unique-string 1.0.0	MIT	Copyright (c) Sindre Sorhus <sindresorhus@gmail.com> (sindresorhus.com)
unpipe 1.0.0	MIT	Copyright (c) 2015 Douglas Christopher Wilson <doug@somethingdoug.com>
unset-value 1.0.0	MIT	Copyright (c) 2015, 2017 Jon Schlinkert
unzip 6.00	Info-ZIP	Copyright (c) 1990-2009 Info-ZIP
unzip-response 2.0.1	MIT	Copyright (c) Sindre Sorhus <sindresorhus@gmail.com> (sindresorhus.com)</sindresorhus@gmail.com>
update-notifier 2.3.0	BSD-2-Clause	Copyright (c) Google
uri-js 4.2.2	BSD-2-Clause	Copyright (c) 2011 Gary Court
urix 0.1.0	MIT	Copyright (c) 2013 Simon Lydell
url-parse-lax 1.0.0	MIT	Copyright (c) Sindre Sorhus <sindresorhus@gmail.com> (sindresorhus.com)</sindresorhus@gmail.com>
user-home 2.0.0	MIT	Copyright (c) Sindre Sorhus <sindresorhus@gmail.com> (sindresorhus.com)
ustr 1.0.4	MIT	Copyright (c) 2007 James Antill
util 0.10.3	MIT	
util-deprecate 1.0.2	MIT	Copyright (c) 2014 Nathan Rajlich <nathan@tootallnate.net>
utils-merge 1.0.1	MIT	Copyright (c) 2013 Jared Hanson
v8-compile-cache 1.1.2	MIT	
validate-npm-package-license.js 3.0.1	Apache-2.0	Copyright (c) Kyle E. Mitchell <kyle@kemitchell.com> (https://kemitchell.com)
vary 1.1.2	MIT	Copyright (c) 2014-2017 Douglas Christopher Wilson

Open Source Software Notice (Cont.)

vizion 0.2.13	Apache-2.0	Copyright (c) 2016 Keymetrics, Inc.
vm-browserify 0.0.4	MIT	
void-elements 2.0.1	MIT	Copyright (c) 2014 hemanth
warlock 0.2.0	MIT	Copyright (c) 2014 Geoff Wagstaff
watchpack 0.2.9	MIT	Copyright (c) 2014 Elan Shanker Copyright (c) 2010-2014 Caolan McMahon Copyright (c) 2014-2016 Jon Schlinkert
webpack 1.15.0	MIT	Copyright (c) 2012 - 2015 Tobias Koppers
webpack-core 0.6.9	MIT	Copyright (c) 2012 - 2013 Tobias Koppers
webpack-node-externals 1.7.2	MIT	Copyright (c) 2016 Liad Yosef
webpack-sources 1.3.0	MIT	Copyright (c) 2017 JS Foundation and other contributors
webpack-version-file 0.1.3	MIT	Copyright (c) 2017 Federico Knüssel
which-module 1.0.0	ISC	Copyright (c) 2016 Contributors
wide-align 1.1.2	ISC	Copyright (c) 2015 Rebecca Turner <me@re-becca.org>
widest-line 2.0.0	MIT	Copyright (c) Sindre Sorhus <sindresorhus@gmail.com> (sindresorhus.com) </sindresorhus@gmail.com>
window-size 0.2.0	MIT	Copyright (c) 2014 Jon Schlinkert
window-size 0.1.0	MIT	Copyright (c) 2014 Jon Schlinkert
winston 2.4.0	MIT	Copyright (c) 2010 Charlie Robbins
winston-compat 0.1.4	MIT	Copyright (c) 2015 Charlie Robbins & the contributors
winston-daily-rotate-file 3.3.0	MIT	
winston-transport 4.2.0	MIT	Copyright (c) 2015 Charlie Robbins & the contributors
with 5.1.1	MIT	Copyright (c) 2013 Forbes Lindesay
wpa_supplicant 2.0	BSD-3-Clause	Copyright (c) 2002-2015 Jouni Malinen <j@w1.fi> and contributors
wrap-ansi 2.1.0	MIT	Copyright (c) Sindre Sorhus <sindresorhus@gmail.com> (sindresorhus.com)
wrappy 1.0.2	ISC	Copyright (c) Isaac Z. Schlueter and contributors
write 0.2.1	MIT	Copyright (c) Sindre Sorhus <sindresorhus@gmail.com> (sindresorhus.com)
write-file-atomic 2.3.0	ISC	Copyright (c) Isaac Z. Schlueter and contributors
x-xss-protection 1.1.0	MIT	Copyright (c) 2014-2015 Jon Schlinkert
XCB 1.11	MIT	Copyright (c) 2001-2006 Bart Massey, Jamey Sharp, and Josh Triplett
xdg-basedir 3.0.0	MIT	Copyright (c) Sindre Sorhus <sindresorhus@gmail.com> (sindresorhus.com)
xdg-utils 1.1.0	MIT	
XML-RPC for C/C++ 1.32.5	BSD-3-Clause	Copyright (c) 2001 by First Peer, Inc. Copyright (c) 2001 by Eric Kidd

Open Source Software Notice (Cont.)

xorg-app-bdftopcf 1.0.5	The Open Group License	Copyright (c) 1991, 1993, 1998 The Open Group
xorg-lib-libICE 1.0.9	The Open Group License	Copyright (c) 1993, 1998 The Open Group
xorg-lib-libpciaccess 0.13.4	ISC, MIT, X11	Copyright (c) 2008 Juan Romero Pardines Copyright (c) 2008 2011 Mark Kettenis Copyright (c) 2009 Michael Lorenz Copyright (c) 2009, 2012 Samuel Thibault Copyright (c) 2006, 2007 IBM Corporation Copyright (c) 2006 Eric Anholt Copyright (c) 2011 Mark Kettenis Copyright (c) 2012 Robert Millan Copyright (c) 2007, 2008, 2009, 2011, 2012, 2013 Oracle and/or its affiliates Copyright (c) 2009, 2012 Red Hat, Inc. Copyright (c) 2007 Paulo R. Zanoni, Tiago Vignatti Copyright (c) 2009 Tiago Vignatti Copyright (c) 2000 The XFree86 Project, Inc.
xorg-lib-libSM 1.2.2	MIT, The Open Group License	Copyright (c) 2002 Oracle and/or its affiliates Copyright (c) 1993, 1998 The Open Group
xorg-lib-libXau 1.0.8	The Open Group License	Copyright 1988, 1993, 1994, 1998 The Open Group
xorg-lib-libXcomposite 0.4.4	HPND, MIT	Copyright (c) 2001, 2003 Keith Packard Copyright (c) 2006, 2007 Oracle and/or its affiliates
xorg-lib-libXcursor 1.1.14	HPND	Copyright (c) 2002 Keith Packard
xorg-lib-libXdamage 1.1.14	HPND	Copyright (c) 2001, 2003 Keith Packard Copyright (c) 2007 Eric Anholt
xorg-lib-libXext 1.3.3	The Open Group License	Copyright (c) 1986, 1987, 1988, 1989, 1994, 1998 The Open Group
xorg-lib-libXfixes 5.0.1	HPND, MIT	Copyright (c) 2001, 2003 Keith Packard Copyright (c) 2006 Oracle and/or its affiliates
xorg-lib-libXfont 1.5.1	BSD-3-Clause	Copyright (c) 1990, 1998 The Open Group
xorg-lib-libXft 2.3.2	HPND	Copyright (c) 2001, 2003 Keith Packard
xorg-lib-libXi 1.7.4	HPND, MIT, The Open Group License	Copyright (c) 1989 Hewlett-Packard Company, Palo Alto, California Copyright (c) 2009, Red Hat, Inc. Copyright (c) 1989, 1998 The Open Group Copyright (c) 2008 Peter Hutterer
xorg-lib-libXinerama 1.1.3	X11	Copyright (c) 1991, 1997 Digital Equipment Corporation, Maynard, Massachusetts
xorg-lib-libXpm 3.5.11	X11	Copyright (c) 1989-1995 GROUPE BULL Copyright (c) 1998 Arnaud LE HORS Copyright (c) 1996 Lorens Younes

Open Source Software Notice (Cont.)

xorg-lib-libXrandr 1.4.2	HPND	Copyright (c) 2000 Compaq Computer Corporation Copyright (c) 2002 Hewlett Packard, Inc. Copyright (c) 2006 Intel Corporation Copyright (c) 2008 Red Hat, Inc. Copyright (c) 2011 Dave Airlie Copyright (c) 2006 Keith Packard
xorg-lib-libXrender 0.9.8	HPND	Copyright (c) 2001, 2003 Keith Packard Copyright (c) 2000 SuSE, Inc.
xorg-lib-libxshmfence 1.2	HPND	Copyright (c) 2013 Keith Packard
xorg-lib-libXt 1.1.4	HPND	Copyright (c) 2001, 2003 Keith Packard Copyright (c) 1987, 1988 by Digital Equipment Corporation, Maynard, Massachusetts
xorg-lib-libXtst 1.2.2	X11	Copyright (c) 1990, 1991 UniSoft Group Limited Copyright (c) 1992, 1994, 1995 X Consortium
xorg-lib-libXxf86vm 1.1.3	X11	Copyright (c) 1995 Kaleb S. KEITHLEY
xtend 4.0.1	MIT	Copyright (c) 2012-2014 Raynos
y18n 4.0.0	ISC	Copyright (c) 2015 Contributors
y18n 3.2.1	ISC	Copyright (c) 2015 Contributors
yajl 2.0.4	ISC	Copyright (c) 2007-2009 Lloyd Hilaiel
yallist 2.1.2	ISC	Copyright (c) Isaac Z. Schlueter and contributors
yaml.js 0.3.0	MIT	Copyright (c) 2010 Jeremy Faivre
yargs 4.8.1	MIT	Copyright (c) 2010 James Halliday (mail@substack.net)
yargs 3.10.0	MIT	Copyright (c) 2010 James Halliday (mail@substack.net)
yargs-parser 2.4.1	ISC	Copyright (c) 2016 Contributors
zip 3.0	Info-ZIP	
zlib 1.2.7	Zlib	Copyright (c) 1995-2013 Jean-loup Gailly and Mark Adler

This product includes software developed by the Apache Software Foundation (<http://www.apache.org/>).

This software is based in part on the work of the Independent JPEG Group.

This product includes software developed by the OpenSSL Project for use in the OpenSSL Toolkit (<http://www.openssl.org/>).

LG PCS400R Pro:Centric Server Warranty

Broadcast Products Welcome to the LG family! We believe that you will be pleased with your new PCS400R Pro:Centric Server. Please read this warranty carefully, it is a "LIMITED WARRANTY" as defined under Federal Law. This warranty gives you specific legal rights, and you may also have other rights that vary from state-to-state within the U.S.A.

LG's RESPONSIBILITY

- Warranty Term** One year parts and labor from date of purchase or delivery date.
- Parts** New or remanufactured replacements for factory-defective parts may be used. Such replacement parts are warranted for the remaining portion of the original warranty period.
- Warranty Service** Warranty service is provided at LG. Customer pays for shipping charges to LG; LG pays for return shipping charges to return PCS400R Pro:Centric Server to customer. Call **1-888-865-3026** for further information.
- Not Covered** This warranty covers manufacturing defects and does not cover installation, adjustment of customer controls, installation or repair of antenna systems, cable converters or cable company-supplied equipment; it also does not cover damage due to misuse, abuse, negligence, acts of God or other causes beyond the control of LG. Any alteration of the product after manufacture voids this warranty in its entirety.

THIS WARRANTY IS IN LIEU OF ANY OTHER WARRANTY, EXPRESS OR IMPLIED, INCLUDING WITHOUT LIMITATION, ANY WARRANTY OF MERCHANTABILITY OR FITNESS FOR A PARTICULAR PURPOSE, AND LG SHALL NOT BE LIABLE FOR ANY CONSEQUENTIAL, INDIRECT, OR INCIDENTAL DAMAGES OF ANY KIND, INCLUDING LOST REVENUES OR PROFITS IN CONNECTION WITH THIS PRODUCT. SOME STATES DO NOT ALLOW LIMITATIONS ON HOW LONG AN IMPLIED WARRANTY LASTS OR THE EXCLUSION OR LIMITATION OF INCIDENTAL OR CONSEQUENTIAL DAMAGES, SO THE ABOVE LIMITATIONS OR EXCLUSIONS MAY NOT APPLY TO YOU.

OWNER'S RESPONSIBILITY

- Effective Warranty Date** Warranty begins on the date of delivery of the PCS400R Pro:Centric Server.
For your convenience, keep the dealer's dated bill of sale or delivery ticket as evidence of the purchase date.
- Installation Guide** Read the Installation & Setup Guide carefully so that you will understand the operation of the PCS400R Pro:Centric Server and how to adjust the settings.
- Warranty Service** **For warranty service information, call 1-888-865-3026.** Parts and service labor that are LG's responsibility (see above) will be provided without charge. Other service is at the owner's expense. If you have any problem in obtaining satisfactory warranty service, call **1-888-865-3026**.
You must provide the model number, serial number and date of purchase or date of original installation.

For Customer Support/Service, please call:

1-888-865-3026

www.lg.com/us/business



LG Pro:Centric®

Pro:Centric, the "Pro:Centric" logo, and the "LG" logo are registered trademarks of LG Electronics Inc. Pro:Idiom is a registered trademark of Zenith Electronics LLC. All other trademarks or registered trademarks are the property of their respective owners.